

Dell Precision Workstation T3600 Owner's Manual

Regulatory Model: D01T
Regulatory Type: D01T002



Notes, cautions, and warnings



NOTE: A NOTE indicates important information that helps you make better use of your computer.



CAUTION: A CAUTION indicates either potential damage to hardware or loss of data and tells you how to avoid the problem.



WARNING: A WARNING indicates a potential for property damage, personal injury, or death.

Copyright © 2015 Dell Inc. All rights reserved. This product is protected by U.S. and international copyright and intellectual property laws. Dell™ and the Dell logo are trademarks of Dell Inc. in the United States and/or other jurisdictions. All other marks and names mentioned herein may be trademarks of their respective companies.

2015 - 05

Rev. A02

Contents

1 Working on Your Computer.....	5
Before Working Inside Your Computer.....	5
Turning Off Your Computer.....	6
After Working Inside Your Computer.....	6
2 Removing and Installing Components.....	7
Recommended Tools.....	7
Removing the Power Supply Unit (PSU).....	7
Installing the Power Supply Unit (PSU).....	8
Removing the Cover.....	8
Installing the Cover.....	9
Removing the Optical Drive	9
Installing the Optical Drive	12
Removing the Thermal Sensor.....	12
Installing the Thermal Sensor.....	12
Removing the Hard Drive.....	12
Installing the Hard Drive	14
Removing the System Fan.....	14
Installing the System Fan.....	19
Removing the Memory.....	19
Installing the Memory.....	20
Removing the Coin-Cell Battery.....	20
Installing the Coin-Cell Battery.....	20
Removing the Heat Sink.....	20
Installing the Heat Sink.....	22
Removing the Processor.....	22
Installing the Processor.....	23
Removing the System Fan.....	23
Installing the System Fan.....	28
Removing the PSU Card.....	28
Installing the PSU Card.....	30
Removing the Front Bezel.....	30
Installing the Front Bezel.....	31
Removing the Front Input/Output (I/O) Panel.....	31
Installing the Front Input/Output (I/O) Panel.....	33
Removing the PCI Card.....	33
Installing the PCI Card.....	33
Removing the Speaker.....	34

Installing the Speaker.....	34
Removing the System Board.....	35
Installing the System Board.....	36
System Board Components.....	37
3 Additional Information.....	38
Memory Module Guidelines.....	38
Power Supply Unit (PSU) Lock.....	38
4 System Setup.....	40
Boot Sequence.....	40
Navigation Keys.....	40
System Setup Options.....	41
Updating the BIOS	46
System and Setup Password.....	47
Assigning a System Password and Setup Password.....	47
Deleting or Changing an Existing System and/or Setup Password.....	48
Disabling a System Password.....	48
5 Diagnostics.....	50
Enhanced Pre-Boot System Assessment (ePSA) Diagnostics.....	50
6 Troubleshooting Your Computer.....	51
Diagnostic LEDs.....	51
Error Messages.....	53
Errors That Do Not Halt Your Computer.....	53
Errors That Soft Halt Your Computer.....	54
7 Technical Specifications.....	55
8 Contacting Dell.....	62

Working on Your Computer

Before Working Inside Your Computer

Use the following safety guidelines to help protect your computer from potential damage and to help to ensure your personal safety. Unless otherwise noted, each procedure included in this document assumes that the following conditions exist:

- You have read the safety information that shipped with your computer.
- A component can be replaced or--if purchased separately--installed by performing the removal procedure in reverse order.

 **WARNING:** Before working inside your computer, read the safety information that shipped with your computer. For additional safety best practices information, see the Regulatory Compliance Homepage at www.dell.com/regulatory_compliance

 **CAUTION:** Many repairs may only be done by a certified service technician. You should only perform troubleshooting and simple repairs as authorized in your product documentation, or as directed by the online or telephone service and support team. Damage due to servicing that is not authorized by Dell is not covered by your warranty. Read and follow the safety instructions that came with the product.

 **CAUTION:** To avoid electrostatic discharge, ground yourself by using a wrist grounding strap or by periodically touching an unpainted metal surface, such as a connector on the back of the computer.

 **CAUTION:** Handle components and cards with care. Do not touch the components or contacts on a card. Hold a card by its edges or by its metal mounting bracket. Hold a component such as a processor by its edges, not by its pins.

 **CAUTION:** When you disconnect a cable, pull on its connector or on its pull-tab, not on the cable itself. Some cables have connectors with locking tabs; if you are disconnecting this type of cable, press in on the locking tabs before you disconnect the cable. As you pull connectors apart, keep them evenly aligned to avoid bending any connector pins. Also, before you connect a cable, ensure that both connectors are correctly oriented and aligned.

 **NOTE:** The color of your computer and certain components may appear differently than shown in this document.

To avoid damaging your computer, perform the following steps before you begin working inside the computer.

1. Ensure that your work surface is flat and clean to prevent the computer cover from being scratched.
2. Turn off your computer (see Turning Off Your Computer).

 **CAUTION:** To disconnect a network cable, first unplug the cable from your computer and then unplug the cable from the network device.

3. Disconnect all network cables from the computer.
4. Disconnect your computer and all attached devices from their electrical outlets.
5. Press and hold the power button while the computer is unplugged to ground the system board.
6. Remove the cover.

△ CAUTION: Before touching anything inside your computer, ground yourself by touching an unpainted metal surface, such as the metal at the back of the computer. While you work, periodically touch an unpainted metal surface to dissipate static electricity, which could harm internal components.

Turning Off Your Computer

△ CAUTION: To avoid losing data, save and close all open files and exit all open programs before you turn off your computer.

1. Shut down the operating system:

- In Windows 7:

Click **Start** , then click **Shut Down**.

- In Windows Vista:

Click **Start** , then click the arrow in the lower-right corner of the **Start** menu as shown below, and then click **Shut Down**.



- In Windows XP:

Click **Start** → **Turn Off Computer** → **Turn Off**. The computer turns off after the operating system shutdown process is complete.

2. Ensure that the computer and all attached devices are turned off. If your computer and attached devices did not automatically turn off when you shut down your operating system, press and hold the power button for about 6 seconds to turn them off.

After Working Inside Your Computer

After you complete any replacement procedure, ensure you connect any external devices, cards, and cables before turning on your computer.

1. Replace the cover.

△ CAUTION: To connect a network cable, first plug the cable into the network device and then plug it into the computer.

2. Connect any telephone or network cables to your computer.

3. Connect your computer and all attached devices to their electrical outlets.

4. Turn on your computer.

5. If required, verify that the computer works correctly by running the Dell Diagnostics.

Removing and Installing Components

This section provides detailed information on how to remove or install the components from your computer.

Recommended Tools

The procedures in this document may require the following tools:

- Small flat-blade screwdriver
- Phillips screwdriver
- Small plastic scribe

Removing the Power Supply Unit (PSU)

1. Follow the procedures in *Before Working Inside Your Computer*.
2. If the PSU is locked, remove the PSU lock screw to release the PSU. For more information, see PSU Lock Feature.
3. Hold the handle bar and press down on the blue latch to release the PSU.

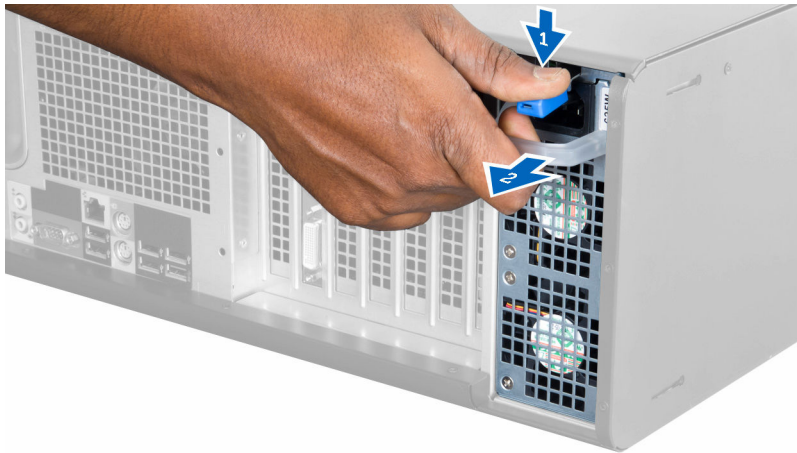

4. Hold the handle bar to slide the PSU out of the computer.



Installing the Power Supply Unit (PSU)

1. Hold the PSU handle and slide the PSU into the computer.
2. Follow the procedures in *After Working Inside Your Computer*.

Removing the Cover

1. Follow the procedures in *Before Working Inside Your Computer*.
2. Lay down the computer on it's right side with the latch facing up.



3. Lift up the cover-release latch.



4. Lift the cover upward to a 45-degree angle, and remove it from the computer.



Installing the Cover

1. Place the computer cover on the chassis.
2. Press down on the computer cover until it clicks into place.
3. Follow the procedures in *After Working Inside Your Computer*.

Removing the Optical Drive

1. Follow the procedures in *Before Working Inside Your Computer*.
2. Remove the cover.

3. Disconnect the data and power cables from the optical drive.

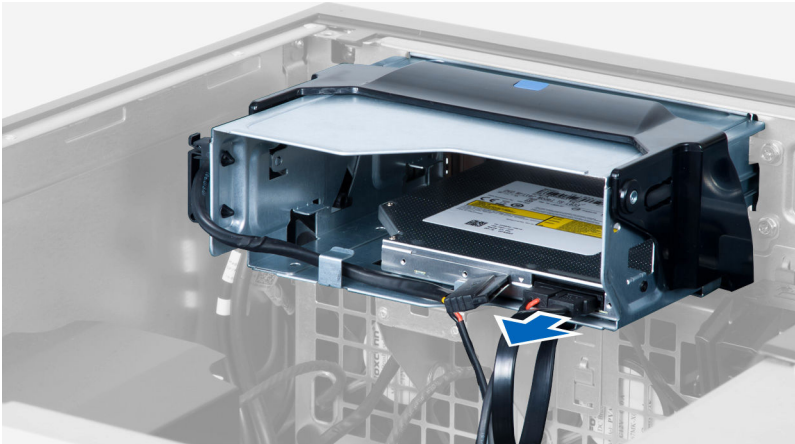

4. Unthread the cables from the latches.

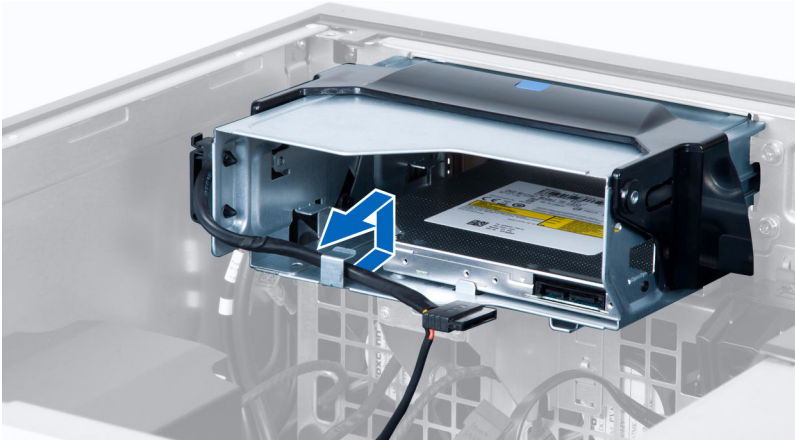

5. Press on the clasp to release the latch holding the cables on the side of the optical-drive cage.

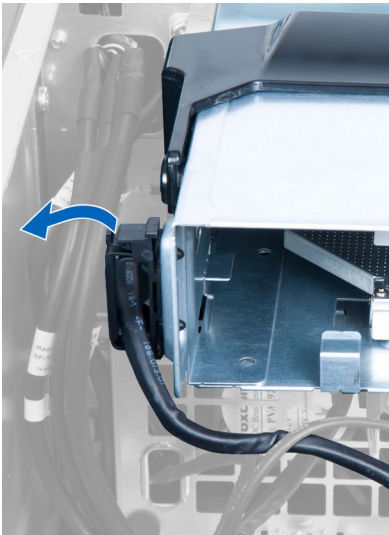

6. Press down on the latch and lift up the cables.

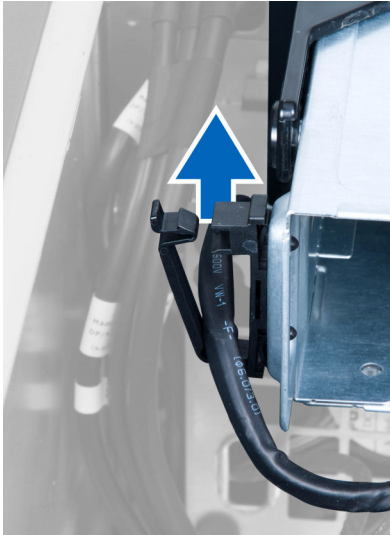

7. Lift up the release latch on top of the ODD cage.

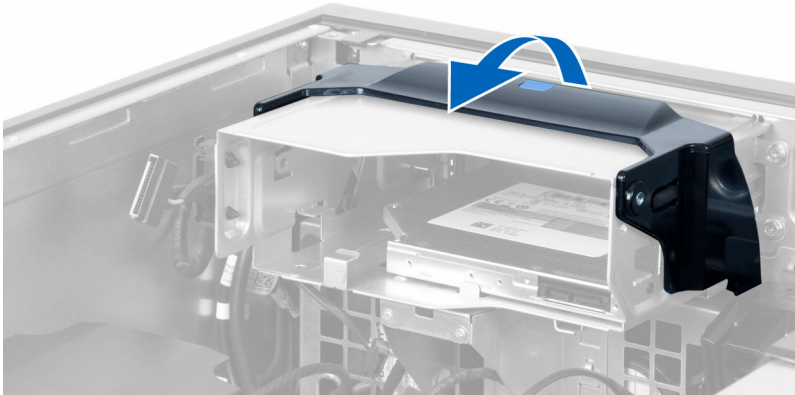

8. Holding the release latch, slide the optical-drive cage from the optical drive compartment.

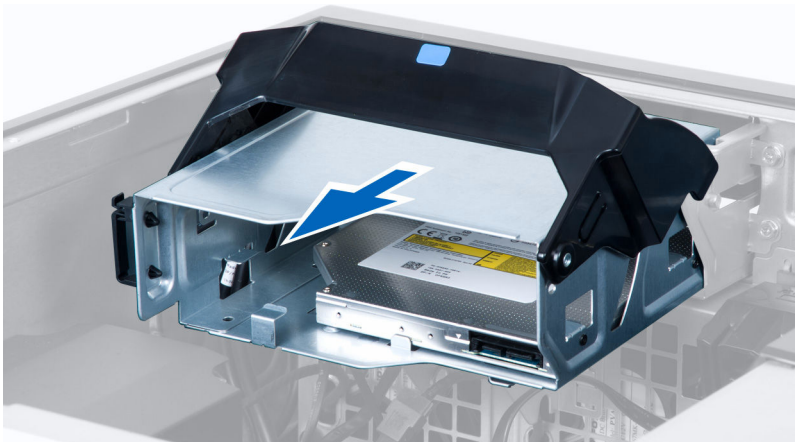

Installing the Optical Drive

1. Lift the release latch, and slide the optical-drive cage inside the compartment.
2. Press on the clasp to release the latch and thread the cables into the holder.
3. Connect the power cable to the back of the optical drive.
4. Connect the data cable to the back of the optical drive.
5. Install the cover.
6. Follow the procedures in *After Working Inside Your Computer*.

Removing the Thermal Sensor

 **NOTE:** The thermal sensor is an optional component and your computer may not ship with it.

1. Follow the procedures in *Before Working On Your Computer*.
2. Remove the cover.
3. Open the latch securing the thermal sensor and remove it from the computer.



Installing the Thermal Sensor

 **NOTE:** The Thermal Sensor is an optional component and your computer may not ship with it.

1. Replace the thermal sensor in its slot and tighten the latch securing it to the computer.
2. Install the cover.
3. Follow the procedures in *After Working Inside Your Computer*.

Removing the Hard Drive

1. Follow the procedures in *Before Working Inside Your Computer*.
2. Remove the cover.
3. Remove the hard-drive power supply cable and the hard-drive data cable from the hard drive.



4. Press in on the latches on either side of the hard drive bracket.

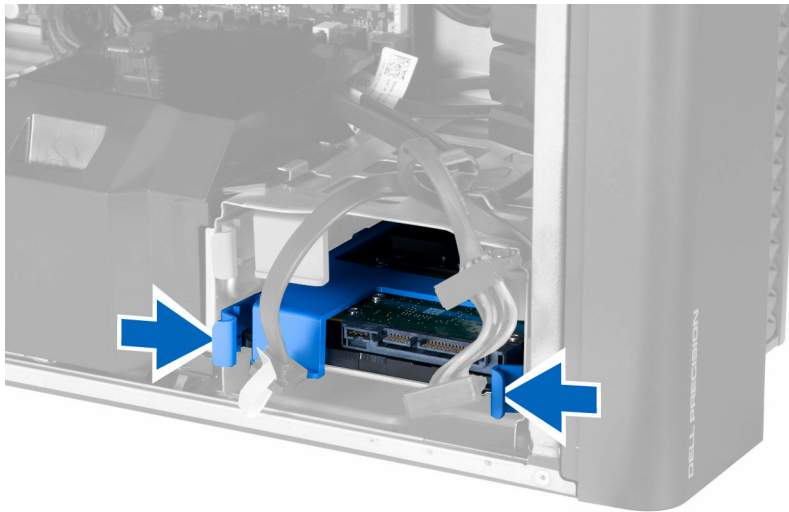

5. Slide the hard drive out of the compartment.

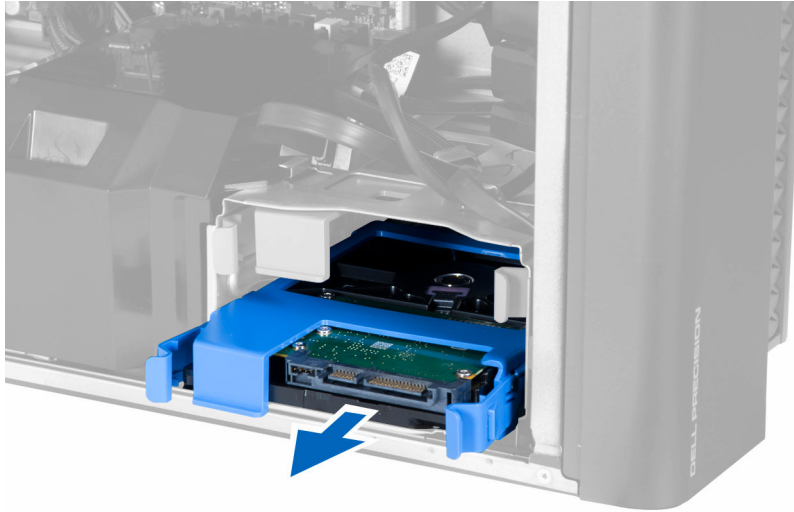

6. If a 2.5-inch hard drive is installed, remove the screws and lift up the drive to remove it from the hard-drive caddy.

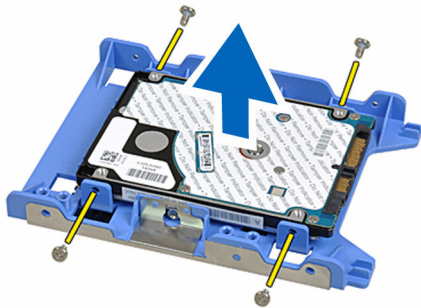

Installing the Hard Drive

1. Press in on the latches of the hard drive cage and slide it inside the compartment.
2. Connect the hard drive power supply cable.
3. Connect the hard drive data cable.
4. Install the cover.
5. Follow the procedures in *After Working Inside Your Computer*.

Removing the System Fan

1. Follow the procedures in *Before Working Inside Your Computer*.
2. Remove:
 - a. cover
 - b. intrusion switch
 - c. PCI card
 - d. hard drive
 - e. optical drive

3. Unthread the system board cable from the latch.

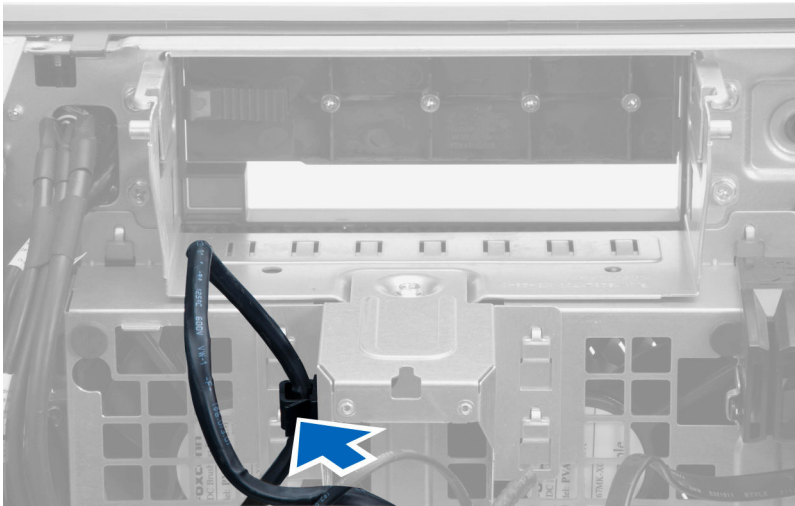

4. Remove the screw that secures metal plate to the system fan.

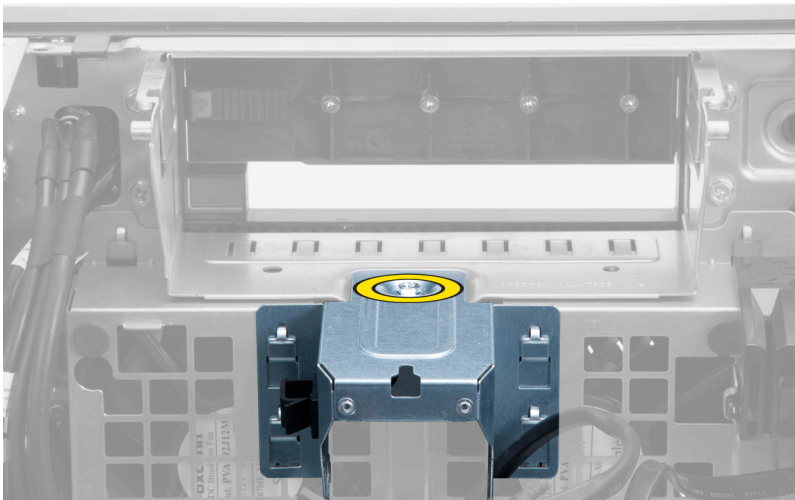

5. Press the latches on either side of the metal plate to release it.

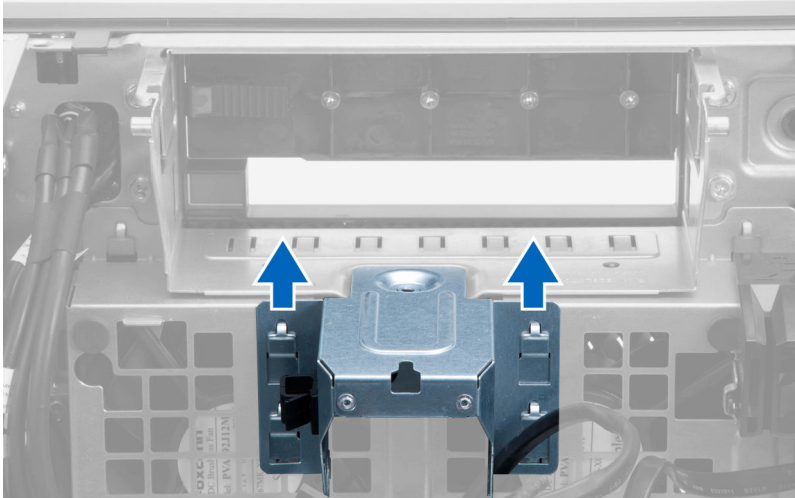

6. Lift the metal plate out the chassis.

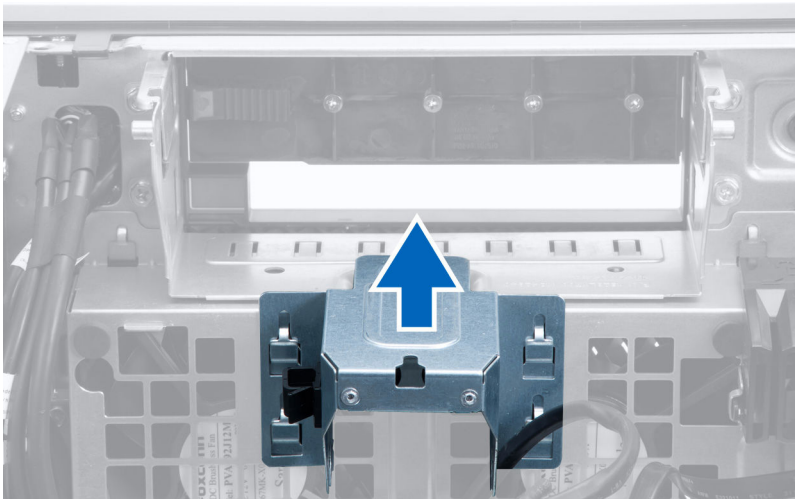

7. Remove the screws that secure the drive bay.

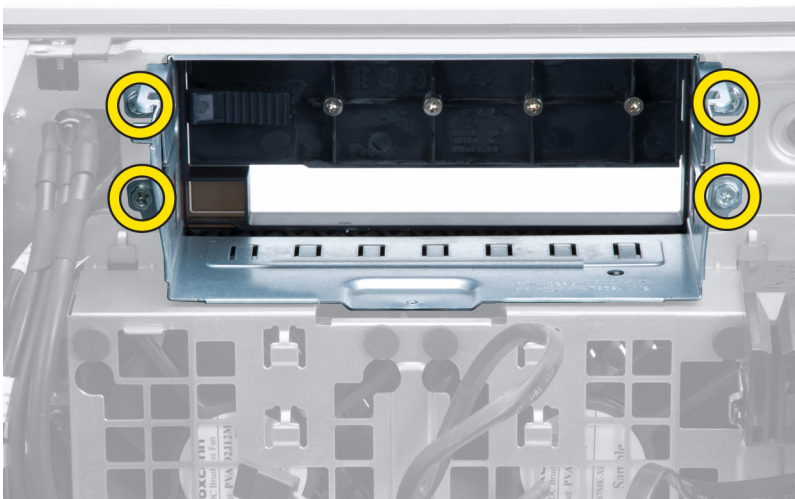

8. Slide the latch out to release the air baffle.

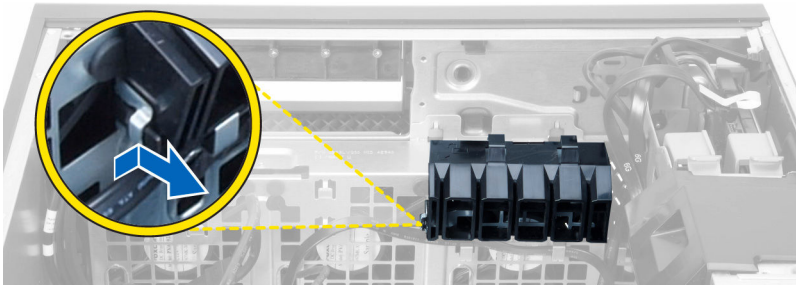

9. Remove the air baffle out the of the computer.

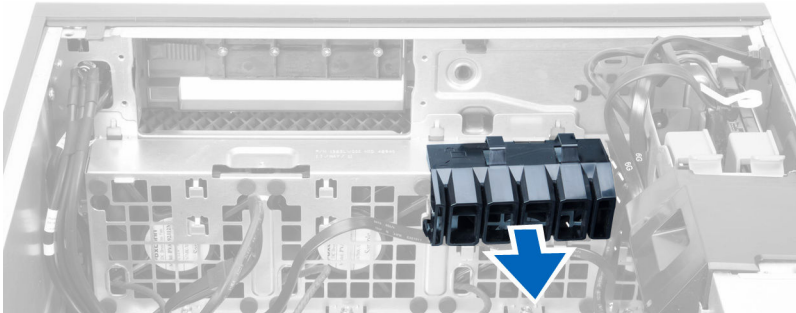

10. Disconnect the system fan cables from the system board.

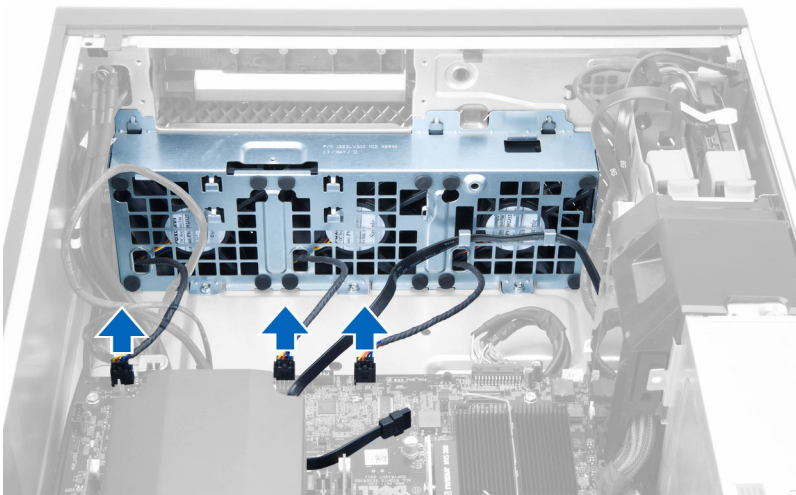

11. Remove the screws that secure system fan assembly to the chassis.

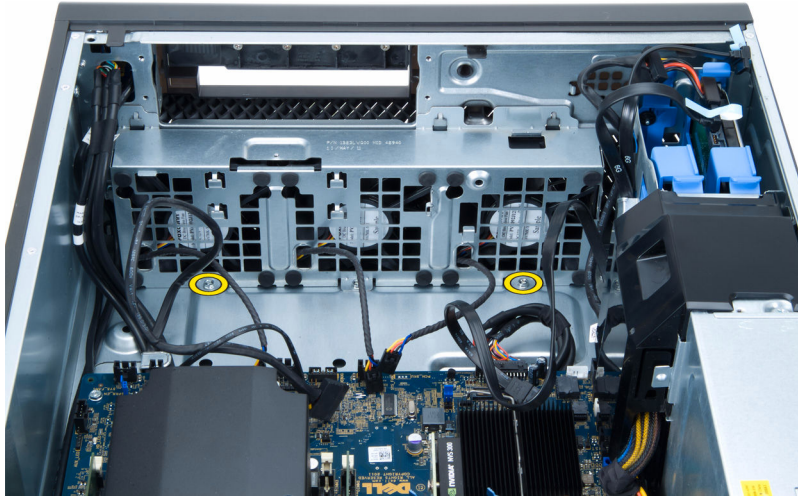

12. Lift the system fan assembly from the chassis.

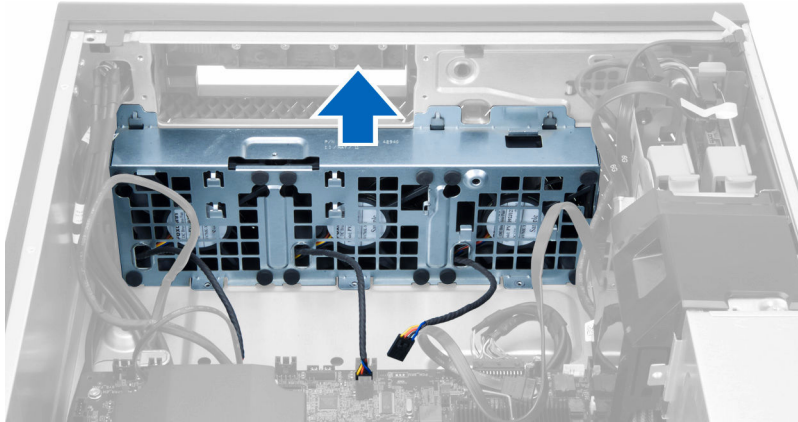

13. Pry away the grommets to remove the system fans from the system fan assembly.

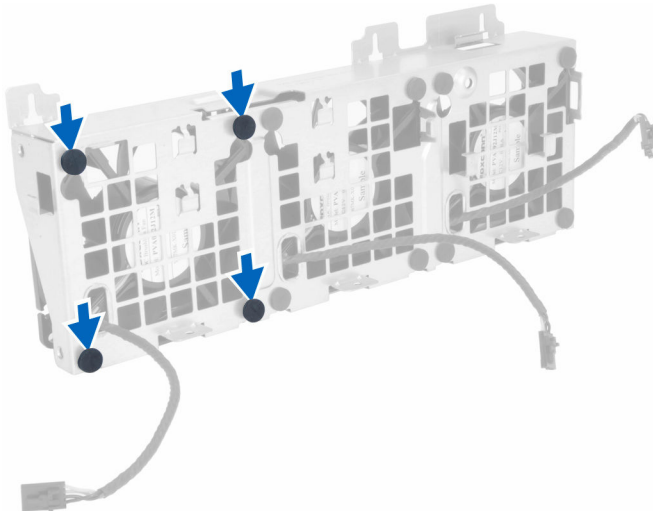

 **CAUTION:** Using excessive force may damage the grommets.

14. Remove the system fans from the system fan assembly.

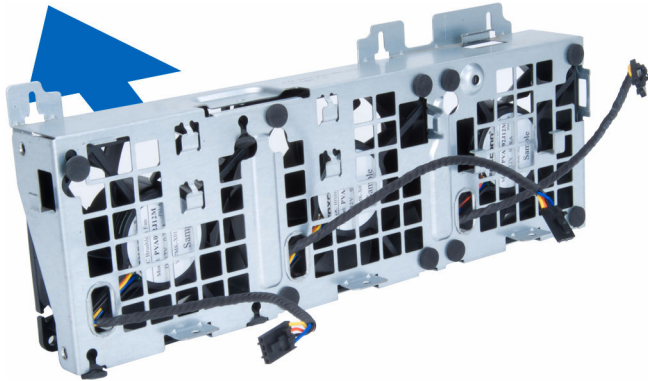

Installing the System Fan

1. Place the fans in the fan assembly and attach the grommets.
2. Place the fan assembly in the chassis.
3. Install the screws to secure the fan assembly to the chassis.
4. Connect the system fan cables to their connectors on the system board.
5. Route the system fan cables out of the opening in the system fan module in the direction of the system board.
6. Place the air baffle in its slot in the computer and insert the latches.
7. Install the screws that secure the drive bay.
8. Replace the metal plate and install the screw that secures metal plate to the system fan.
9. Route and connect the system board cable to its connector.
10. Install:
 - a. optical drive
 - b. hard drive
 - c. PCI card
 - d. intrusion switch
 - e. cover
11. Follow the procedures in *After Working Inside Your Computer*.

Removing the Memory

1. Follow the procedures in *Before Working Inside Your Computer*.
2. Remove the cover.
3. Press down on the memory-securing clips on each side of the memory module, and lift the memory module upwards to remove it from the computer.

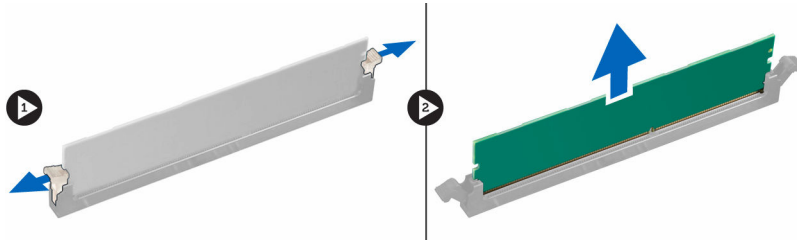

Installing the Memory

1. Insert the memory module into the memory socket.
2. Press down on the memory module until the securing clips secure the memory in place.
3. Install the cover.
4. Follow the procedures in *After Working Inside Your Computer*.

Removing the Coin-Cell Battery

1. Follow the procedures in *Before Working Inside Your Computer*.
2. Remove the cover.
3. Press the release latch away from the battery to allow the battery to pop-up from the socket. Lift the coin-cell battery out of the computer.

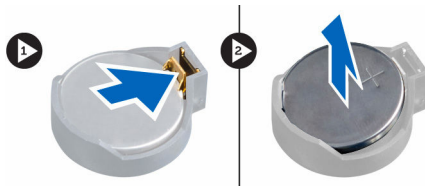

Installing the Coin-Cell Battery

1. Place the coin-cell battery into the slot on the system board.
2. Press the coin-cell battery downward until the release latch springs back into place and secures it.
3. Install the cover.
4. Follow the procedures in *After Working Inside Your Computer*.

Removing the Heat Sink

1. Follow the procedures in *Before Working Inside Your Computer*.
2. Remove the cover.
3. Disconnect the heat-sink cable from the system board.

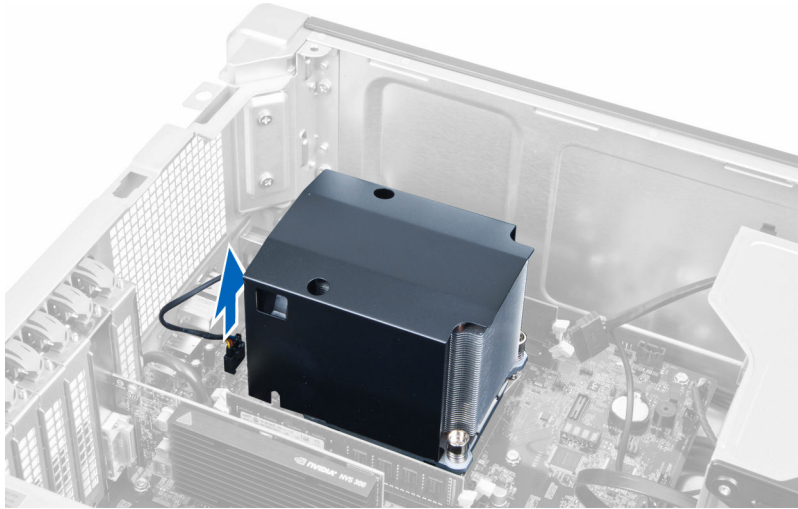

4. Loosen the screws that secure the heat sink.

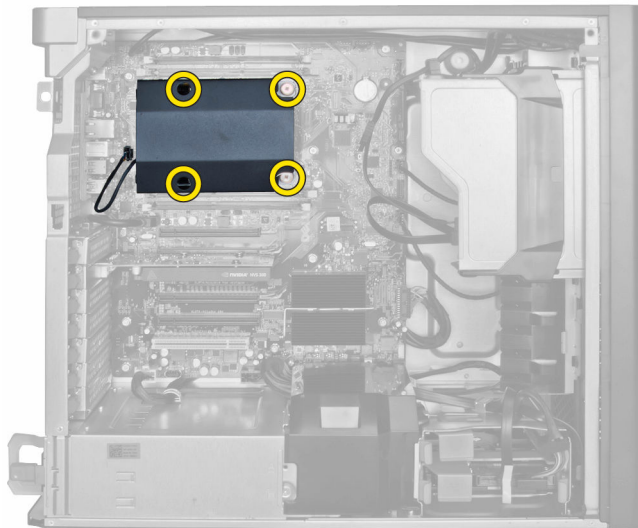

5. Lift up the heat sink and remove it from the computer.

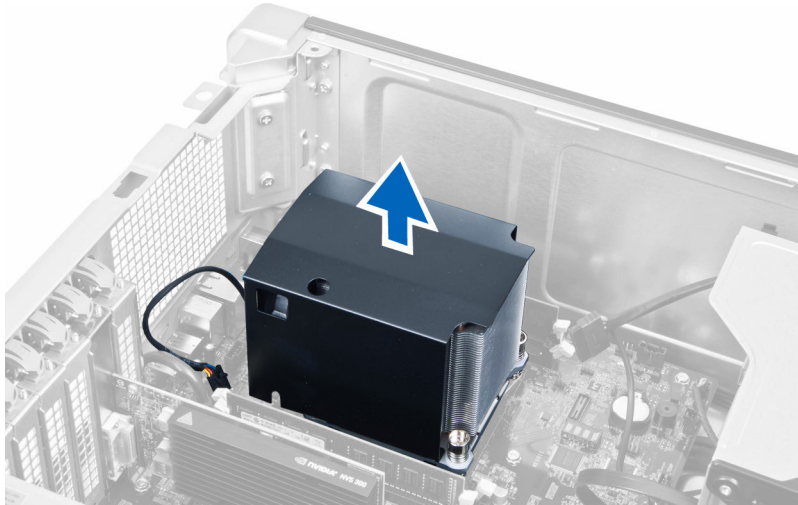

Installing the Heat Sink

1. Place the heat sink inside the computer.
2. Tighten the captive screws to secure the heat sink to the system board.
3. Connect the heat-sink cable to the system board.
4. Install the cover.
5. Follow the procedures in *After Working Inside Your Computer*.

Removing the Processor

1. Follow the procedures in *Before Working Inside Your Computer*.
2. Remove:
 - a. cover
 - b. heat sink
3. To remove the processor:
 -  **NOTE:** The processor cover is secured by two levers. They have icons that indicate which lever needs to be opened first and which lever closes first.
 - a. Press down on the first lever holding the processor cover in place and release it sideways from its retention hook.
 - b. Repeat step 'a' to release the second lever from its retention hook.
 - c. Lift up and remove the processor cover.
 - d. Lift the processor to remove it from the socket and place it in antistatic package.

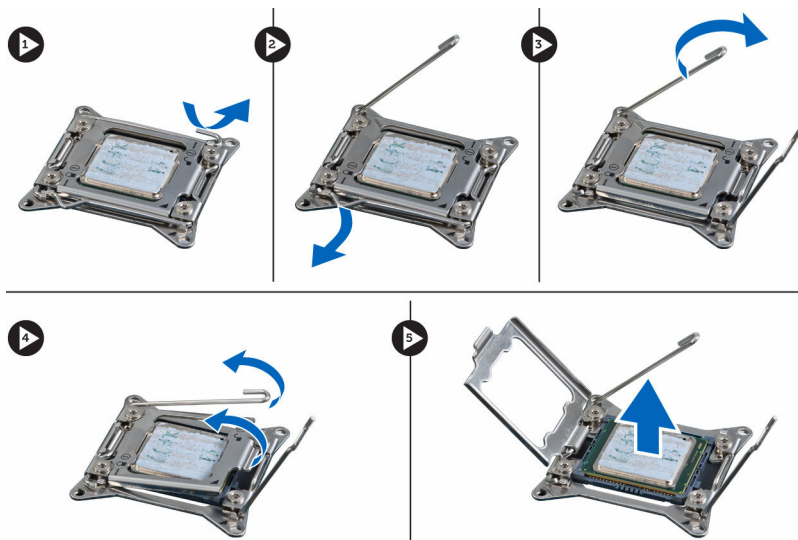

4. Repeat the above steps to remove the second processor (if available) from the computer.
To verify if your computer has dual processor slots, see the System Board Components.

Installing the Processor

1. Place the processor in its socket.
2. Replace the processor cover.
 -  **NOTE:** The processor cover is secured by two levers. They have icons that indicate which lever needs to be opened first and which lever closes first
3. Slide the first lever sideways into the retention hook to secure the processor.
4. Repeat step '3' to slide the second lever into the retention hook.
5. Install:
 - a. heat sink
 - b. cover
6. Follow the procedures in *After Working Inside Your Computer*.

Removing the System Fan

1. Follow the procedures in *Before Working Inside Your Computer*.
2. Remove:
 - a. cover
 - b. intrusion switch
 - c. PCI card
 - d. hard drive
 - e. optical drive
3. Unthread the system board cable from the latch.



4. Remove the screw that secures metal plate to the system fan.

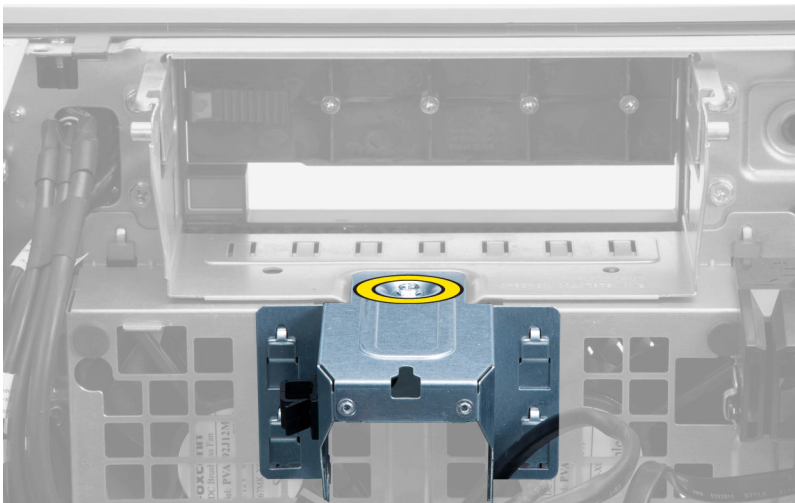

5. Press the latches on either side of the metal plate to release it.

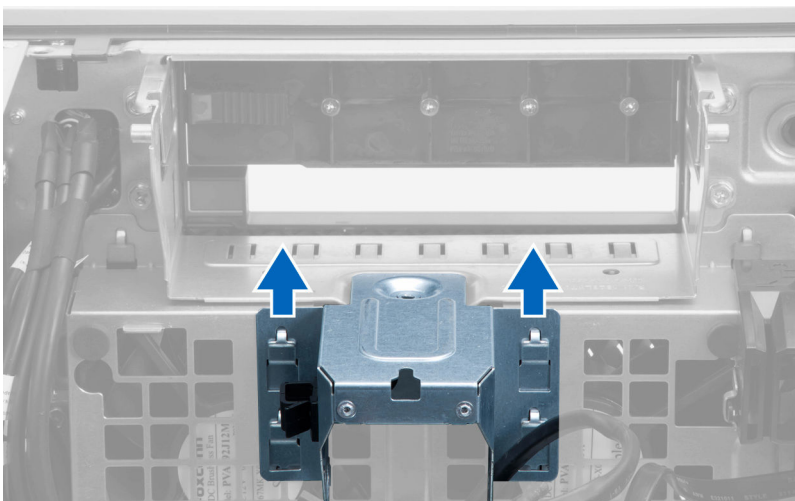

6. Lift the metal plate out the chassis.

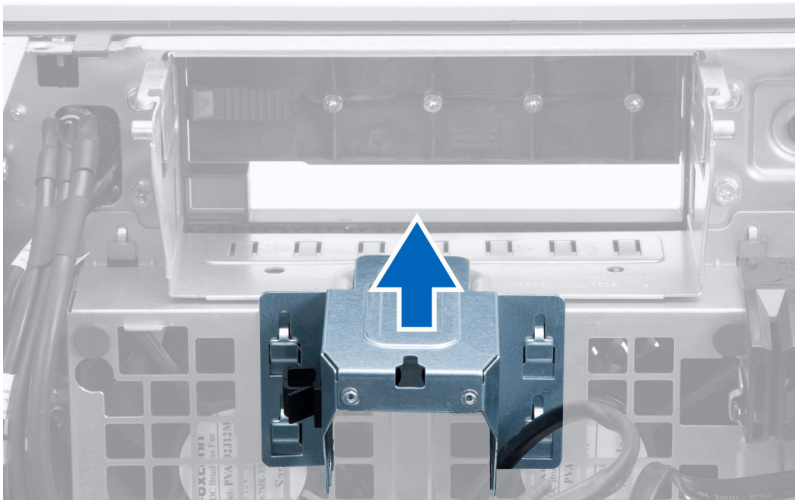

7. Remove the screws that secure the drive bay.

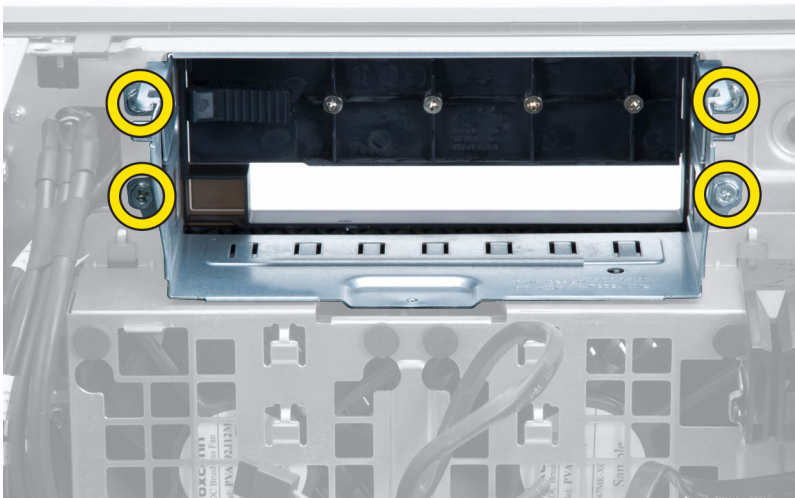

8. Slide the latch out to release the air baffle.

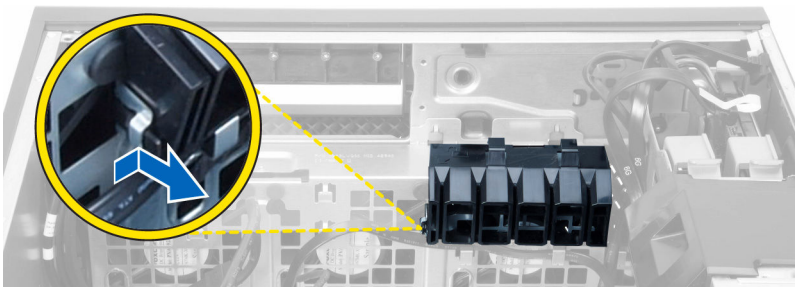

9. Remove the air baffle out the of the computer.

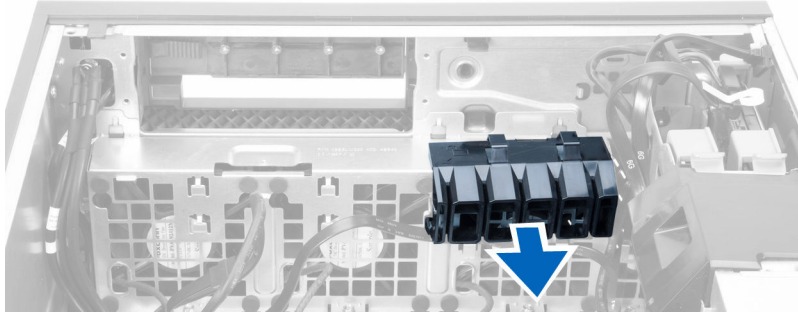

10. Disconnect the system fan cables from the system board.

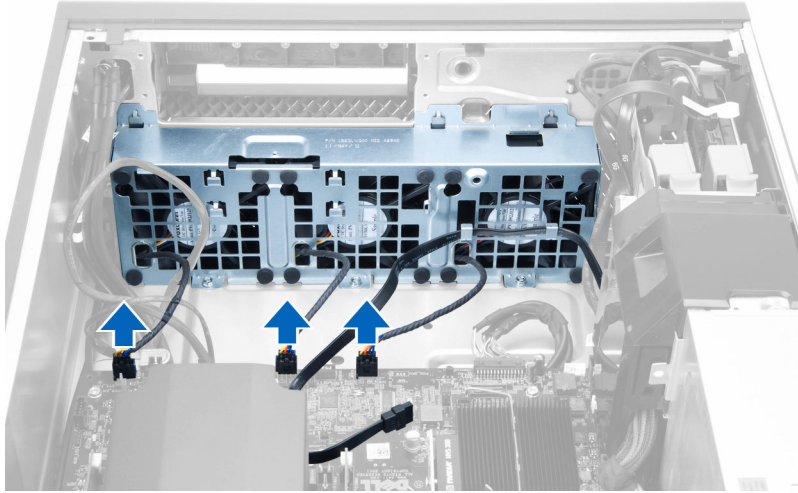

11. Remove the screws that secure system fan assembly to the chassis.



12. Lift the system fan assembly from the chassis.

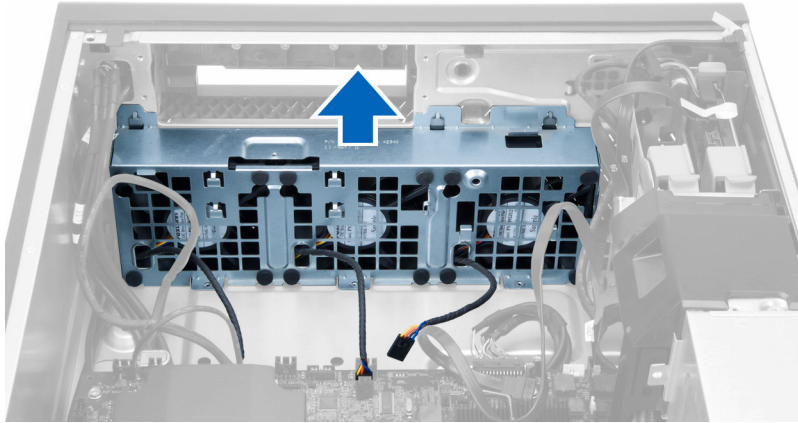

13. Pry away the grommets to remove the system fans from the system fan assembly.

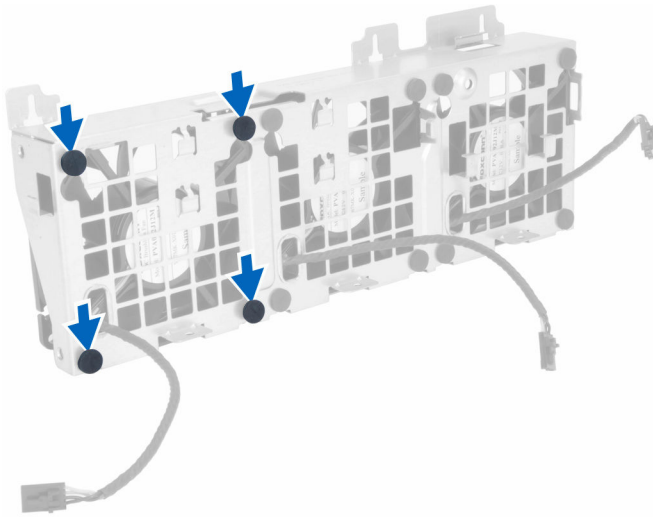

⚠ CAUTION: Using excessive force may damage the grommets.

14. Remove the system fans from the system fan assembly.

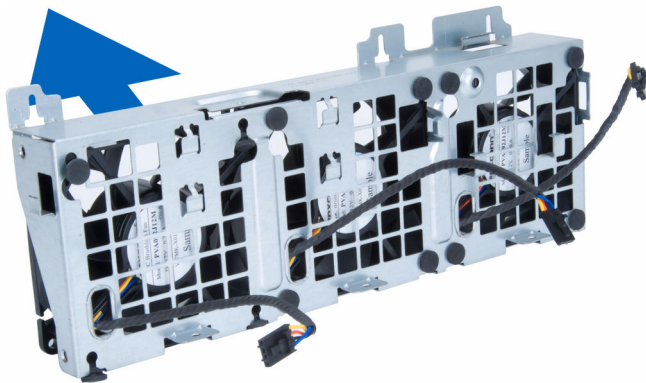

Installing the System Fan

1. Place the fans in the fan assembly and attach the grommets.
2. Place the fan assembly in the chassis.
3. Install the screws to secure the fan assembly to the chassis.
4. Connect the system fan cables to their connectors on the system board.
5. Route the system fan cables out of the opening in the system fan module in the direction of the system board.
6. Place the air baffle in its slot in the computer and insert the latches.
7. Install the screws that secure the drive bay.
8. Replace the metal plate and install the screw that secures metal plate to the system fan.
9. Route and connect the system board cable to its connector.
10. Install:
 - a. optical drive
 - b. hard drive
 - c. PCI card
 - d. intrusion switch
 - e. cover
11. Follow the procedures in *After Working Inside Your Computer*.

Removing the PSU Card

1. Follow the procedures in *Before Working On Your Computer*.
2. Remove the cover.
3. Slide the baffle cover from its slot towards the front.

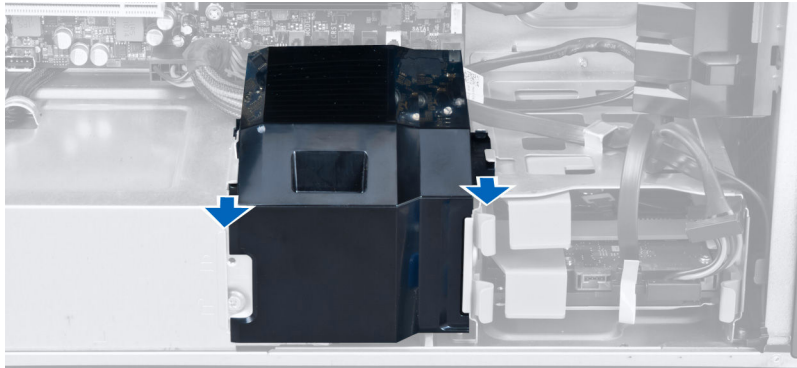

4. Remove the baffle cover from the computer.

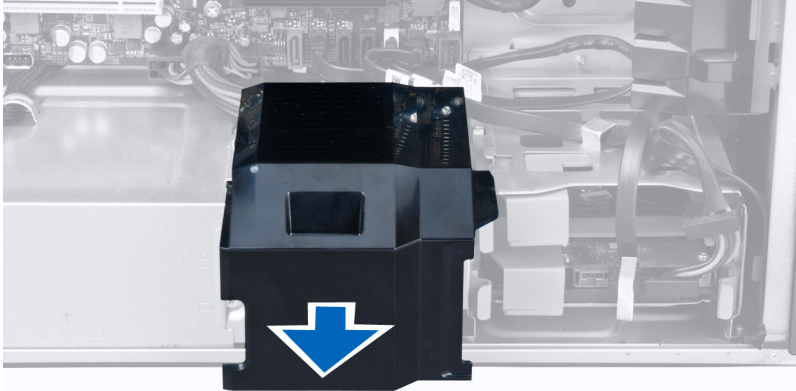

5. Remove the power cables.

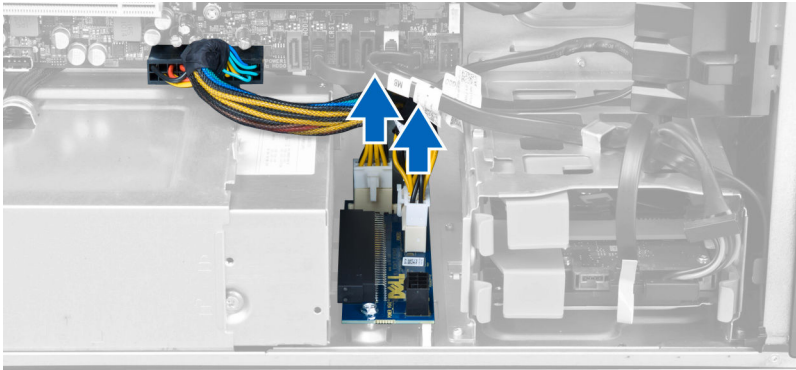

6. Remove the screws securing the PSU card to the slot.

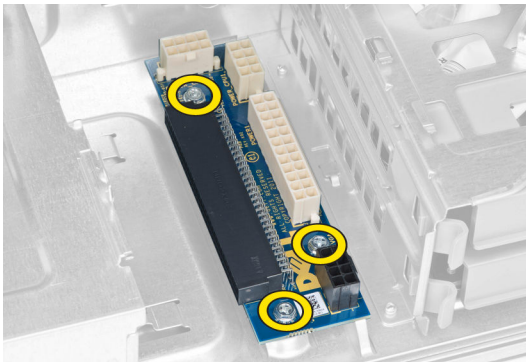

7. Remove the PSU card from the computer.

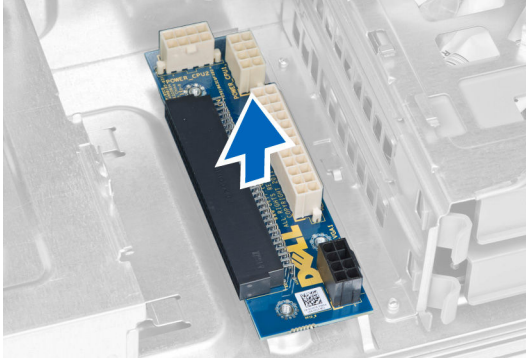

Installing the PSU Card

1. Replace the PSU card in its slot.
2. Tighten the screws to secure the PSU card in its slot.
3. Replace the power cables in their slots.
4. Replace the baffle cover in its slot.
5. Install the cover.
6. Follow the procedures in *After Working Inside Your Computer*.

Removing the Front Bezel

1. Follow the procedures in *Before Working Inside Your Computer*.
2. Remove the cover.
3. Gently pry the front bezel retention clips away from the chassis located at the edge of front bezel.

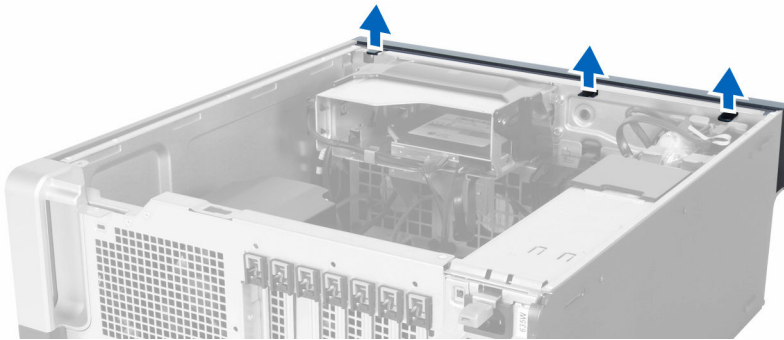

4. Rotate and pull the bezel panel away from the computer to release the hooks on the opposite edge of the bezel from the chassis.



Installing the Front Bezel

1. Insert the hooks along the bottom edge of the front panel into the slots on the chassis front.
2. Rotate the bezel towards the computer to engage the front-bezel retention clips until they click into place.
3. Install the cover.
4. Follow the procedures in *After Working Inside Your Computer*.

Removing the Front Input/Output (I/O) Panel

1. Follow the procedures in *Before Working On Your Computer*.
2. Remove:
 - a. cover
 - b. front bezel
3. Remove the screws that secure the USB 3.0 module to the front I/O panel.

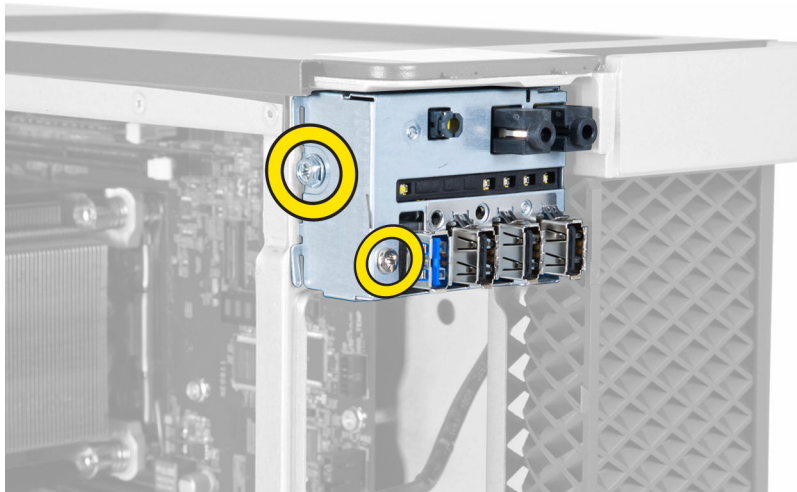

4. Remove the USB 3.0 module from the chassis.

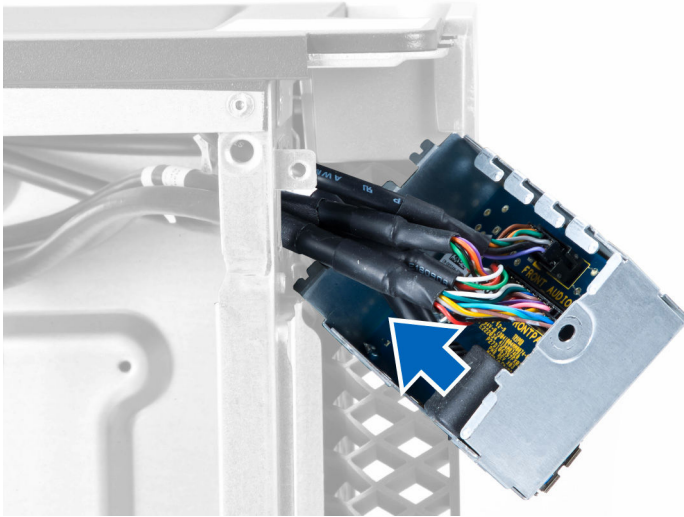

5. Disconnect the cables to release the I/O panel.

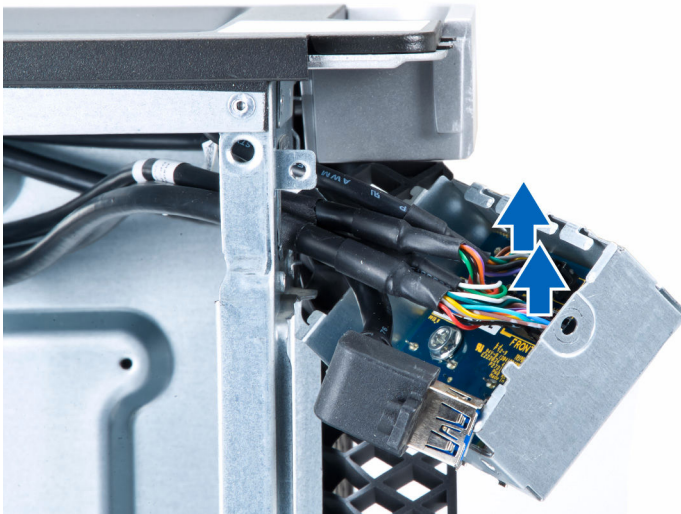

6. Remove the screws which secure the front I/O panel to the chassis.

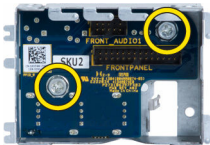

7. Remove the front I/O panel from the chassis.



Installing the Front Input/Output (I/O) Panel

1. Replace the front I/O panel in its slot.
2. Tighten the screws securing the front I/O panel to the chassis
3. Attach the cables to the I/O panel.
4. Slide the USB 3.0 module in its slot.
5. Tighten the screws securing the USB 3.0 module to the front I/O panel.
6. Install:
 - a. front bezel
 - b. cover
7. Follow the procedures in *After Working Inside Your Computer*.

Removing the PCI Card

1. Follow the procedures in *Before Working Inside Your Computer*.
2. Remove the left cover.
3. Perform the following steps as shown in the illustration:
 - a. Open the plastic latch fastening the PCI card in its slot [1].
 - b. Press down the latch and pull the PCI card away from the computer [2, 3].

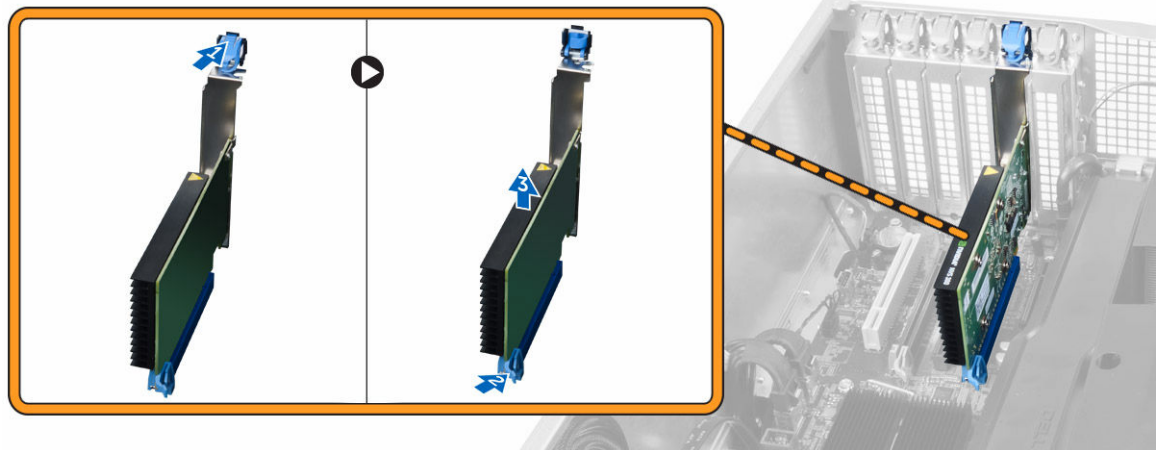

Installing the PCI Card

1. Push the expansion card into the card slot and secure the latch.
2. Install the plastic latch that secures the PCI card to the card slot.
3. Install the left cover.
4. Follow the procedures in *After Working Inside Your Computer*.

Removing the Speaker

1. Follow the procedures in *Before Working On Your Computer*.
2. Remove the cover.
3. Disconnect the speaker cable from the system board.

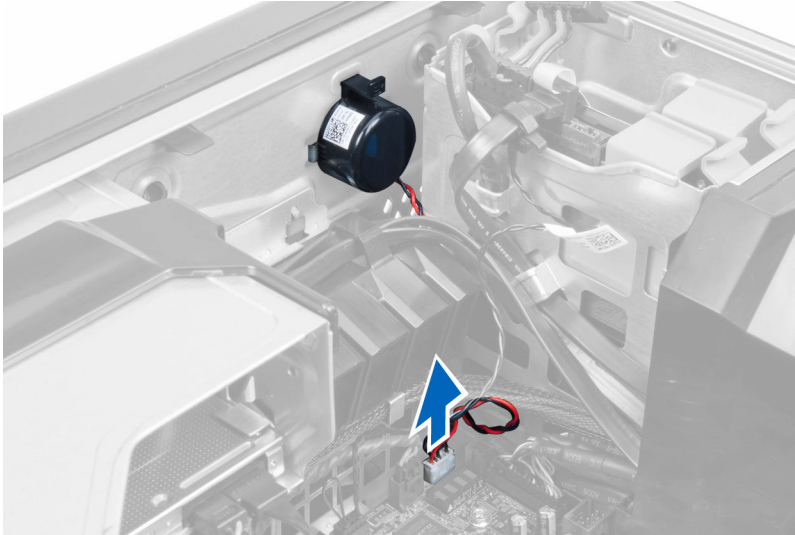

4. Press down the clasp, lift and remove the speaker.

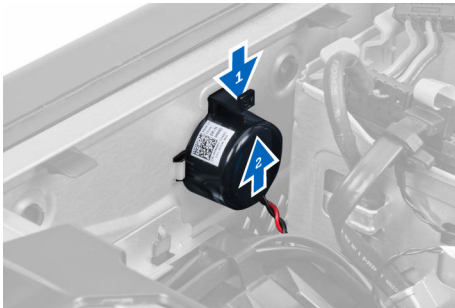

Installing the Speaker

1. Replace the speaker and fix the clasp.
2. Connect the speaker cable to the system board.
3. Install the cover.
4. Follow the procedures in *After Working Inside Your Computer*.

Removing the System Board

1. Follow the procedures in *Before Working On Your Computer*.
2. Remove:
 - a. PSU
 - b. cover
 - c. optical drive
 - d. coin-cell battery
 - e. thermal sensor
 - f. hard drive
 - g. system fan
 - h. PSU card
 - i. PCI card
 - j. front input/output (I/O) panel
 - k. speakers
 - l. heat sink
 - m. heat-sink fan
 - n. memory module(s)
 - o. processor
3. Disconnect all the cables from the system board.

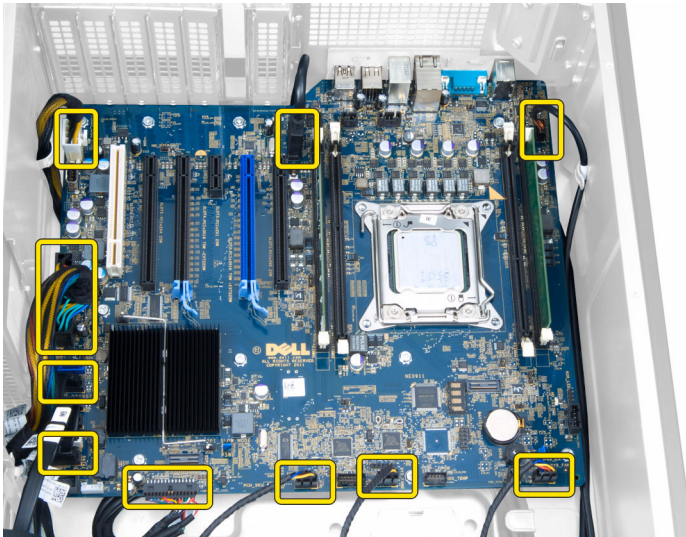

4. Remove the screws that secure the system board to the chassis.

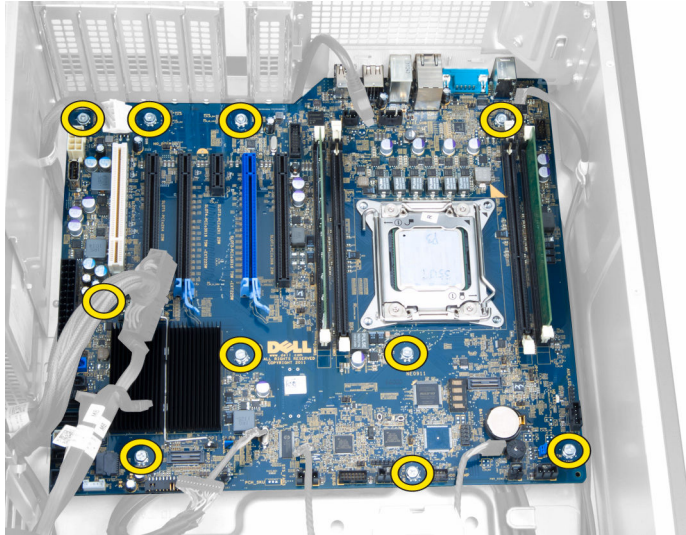

5. Lift the system board in an upward direction and remove it from the computer.

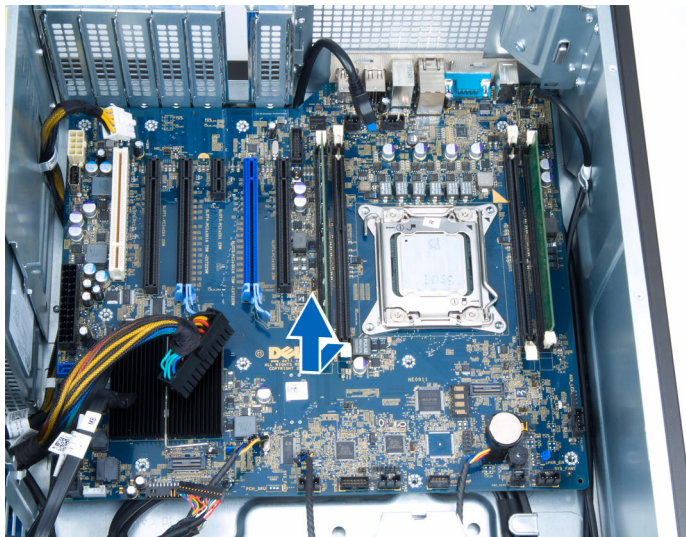

Installing the System Board

1. Align the system board to the port connectors on the rear of the chassis and place the system board in the chassis.
2. Tighten the screws that secure the system board to the chassis.
3. Connect the cables to the system board.
4. Install:
 - a. processor
 - b. memory module(s)
 - c. heat-sink fan
 - d. heat sink
 - e. speakers
 - f. front input/output (I/O) panel

- g. PCI card
- h. PSU card
- i. system fan
- j. hard drive
- k. thermal sensor
- l. coin-cell battery
- m. optical drive
- n. cover
- o. PSU

5. Follow the procedures in *After Working Inside Your Computer*.

System Board Components

The following image displays the system board components.

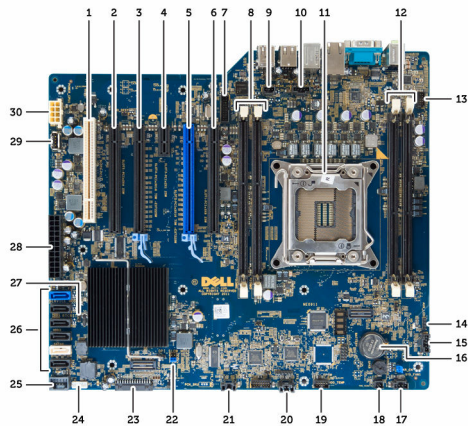

- | | |
|--|------------------------------------|
| 1. PCI slot | 2. PCIe x16 slot (wired as x4) |
| 3. PCIe x16 slot | 4. PCIe x1 slot |
| 5. PCIe x16 slot (accelerated graphics port) | 6. PCIe x16 slot (wired as x4) |
| 7. USB 3.0 front panel connector | 8. DIMM slots |
| 9. intrusion switch connector | 10. CPU fan socket |
| 11. CPU | 12. DIMM slots |
| 13. hard drive temperature sensor | 14. front panel audio connector |
| 15. HDD1 fan connector | 16. coin-cell battery |
| 17. system fan 1 connector | 18. remote power enable |
| 19. HDD temperature sensor connector | 20. system fan 2 connector |
| 21. system fan 3 connector | 22. PSWD jumper |
| 23. front panel & USB 2.0 connector | 24. internal speaker connector |
| 25. internal USB 2.0 connector | 26. HDD & optical drive connectors |
| 27. RTCRST jumper | 28. 24-pin power connector |
| 29. internal USB 2.0 connector | 30. CPU power connector |

Additional Information

This section provides information for the additional features that are part of your computer.

Memory Module Guidelines

To ensure optimal performance of your computer, observe the following general guidelines when configuring your system memory:

- Memory modules must be installed beginning with the first socket.
 - ✎ **NOTE:** The memory sockets in your computer may be labeled differently depending on the hardware configuration. For example, A1, A2 or 1,2,3.
 - ✎ **NOTE:** Memory modules should be installed in pairs of matched memory size, speed, and technology. If the memory modules are not installed in matched pairs, the computer will continue to operate, but with a slight reduction in performance.

Power Supply Unit (PSU) Lock

The PSU lock prevents the removal of the PSU from the chassis.

- ✎ **NOTE:** To lock or unlock the PSU, always ensure that the cover of the chassis is removed. For information on removing the cover, see [Removing the cover](#).

To secure the PSU, remove the screw from the unlock screw location and tighten the screw to the lock location. Similarly, to unlock the PSU, remove the screw from the lock screw location and tighten the screw to the unlock screw location.

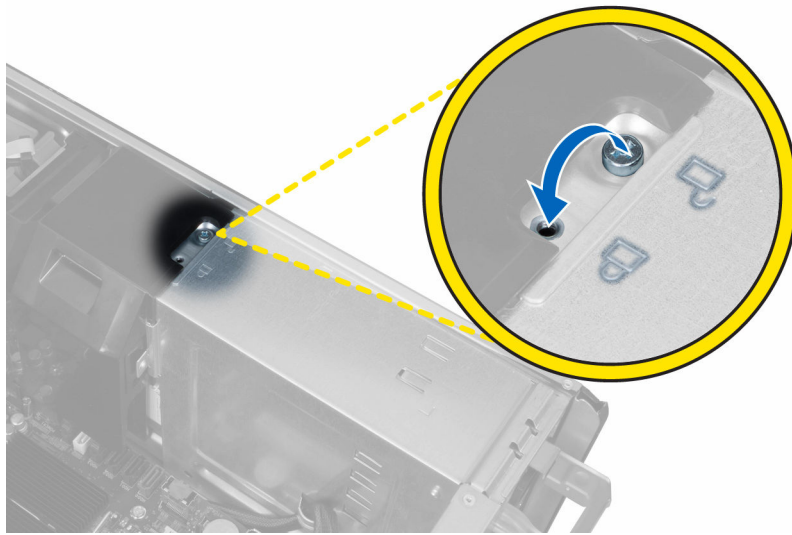

System Setup

System Setup enables you to manage your computer hardware and specify BIOS-level options. From the System Setup, you can:

- Change the NVRAM settings after you add or remove hardware
- View the system hardware configuration
- Enable or disable integrated devices
- Set performance and power management thresholds
- Manage your computer security

Boot Sequence

Boot Sequence allows you to bypass the System Setup-defined boot device order and boot directly to a specific device (for example: optical drive or hard drive). During the Power-on Self Test (POST), when the Dell logo appears, you can:

- Access System Setup by pressing <F2> key
- Bring up the one-time boot menu by pressing <F12> key

The one-time boot menu displays the devices that you can boot from including the diagnostic option. The boot-menu options are:

- Removable Drive (if available)
- STXXXX Drive

 **NOTE:** XXX denotes the SATA drive number.

- Optical Drive
- Diagnostics

 **NOTE:** Choosing Diagnostics, will display the **ePSA diagnostics** screen.

The boot sequence screen also displays the option to access the System Setup screen.

Navigation Keys

The following table displays the system setup navigation keys.



 **NOTE:** For most of the system setup options, changes that you make are recorded but do not take effect until you restart the system.

Table 1. Navigation Keys

Keys	Navigation
Up arrow	Moves to the previous field.
Down arrow	Moves to the next field.
<Enter>	Allows you to select a value in the selected field (if applicable) or follow the link in the field.
Spacebar	Expands or collapses a drop-down list, if applicable.
<Tab>	Moves to the next focus area.
	 NOTE: For the standard graphics browser only.
<Esc>	Moves to the previous page till you view the main screen. Pressing <Esc> in the main screen displays a message that prompts you to save any unsaved changes and restarts the system.
<F1>	Displays the System Setup help file.

System Setup Options



 **NOTE:** Depending on your computer and its installed devices, the items listed in this section may or may not appear.

Table 2. General

Option	Description
System Board	<p>This section lists the primary hardware features of your computer.</p> <ul style="list-style-type: none"> • System Information • Device Information • PCI Information • Memory Information • Processor Information
Date/Time	<p>Allows you to set the date and time. The changes to the system date and time takes effect immediately.</p>
Boot Sequence	<p>Allows you to change the order in which the computer attempts to find an operating system.</p> <ul style="list-style-type: none"> • Diskette Drive • Internal HDD • USB Storage Device • CD/DVD/CD-RW Drive • Onboard NIC
Boot List Option	<p>Allows you to change the boot list option.</p> <ul style="list-style-type: none"> • Legacy

Option	Description
	<ul style="list-style-type: none"> UEFI

Table 3. System Configuration

Option	Description
Integrated NIC	<p>Allows you to configure the integrated network controller. The options are:</p> <ul style="list-style-type: none"> Disabled Enabled (Default Setting)
USB Controller	<p>Allows you to control the USB controller. The options are:</p> <ul style="list-style-type: none"> Enable USB Controller (Default Setting) Disable USB Mass Storage Dev Disable USB Controller
Serial Port	<p>Identifies and defines the serial port settings. You can set the serial port to:</p> <ul style="list-style-type: none"> Disabled Auto COM1 (Default Setting) COM2 COM3 COM4 <p> NOTE: The operating system may allocate resources even if the setting is disabled.</p>
SATA Operation	<p>Allows you to configure the internal SATA hard-drive controller. The options are:</p> <ul style="list-style-type: none"> Disabled ATA AHCI (Default Setting) <p> NOTE: SATA is configured to support RAID mode.</p>
USB Configuration	<p>Allows you to define the USB configuration. The options are:</p> <ul style="list-style-type: none"> Enable Boot Support Front USB Ports Rear USB Ports USB3 Ports
SMART Reporting	<p>This field controls if the hard drive errors for the integrated drives are reported during</p>

Option	Description
	<p>system startup. This technology is part of the SMART (Self Monitoring Analysis and Reporting Technology) specification.</p> <ul style="list-style-type: none"> • Enable SMART Reporting - This option is disabled by default.
PCI Bus Configuration	<p>Allows you to configure the PCI buses. The options are:</p> <ul style="list-style-type: none"> • 64 PCI Buses (Default)
Audio	<p>Allows you enable or disable the audio feature. Default Setting: Audio is enabled</p>
Drives	<p>Allows you to configure the SATA drives on board. The options are:</p> <ul style="list-style-type: none"> • SATA-0 • SATA-1 <p>Default Setting: All drives are enabled.</p>
HDD Fans	<p>Allows you to control the HDD fans. Default Setting: depends on the system configuration</p>

Table 4. Performance





Option	Description
Multi Core Support	<p>This field specifies whether the processor will have one or all cores enabled. The performance of some applications will improve with the additional cores. This option is enabled by default. Allows you to enable or disable multi-core support for the processor. The options are:</p> <ul style="list-style-type: none"> • All (Default Setting) • 1 • 2
Intel SpeedStep	<p>Allows you to enable or disable the Intel SpeedStep feature. Default Setting: Enable Intel SpeedStep</p>
C States Control	<p>Allows you to enable or disable the additional processor sleep states. Default Setting: Enabled</p>
Intel TurboBoost	<p>Allows you to enable or disable the Intel TurboBoost mode of the processor. Default Setting: Enable Intel TurboBoost</p>

Option	Description
Hyper-Thread Control	Allows you to enable or disable the HyperThreading in the processor. Default Setting: Enabled
Cache Prefetch	Default Setting: Enable Hardware Prefetch and Adjacent Cache Line Prefetch
RMT	Default Setting: Enabled

Table 5. Virtualization Support

Option	Description
Virtualization	This option specifies whether a Virtual Machine Monitor (VMM) can utilize the additional hardware capabilities provided by Intel Virtualization technology. <ul style="list-style-type: none"> • Enable Intel Virtualization Technology - This option is enabled by default.
VT for Direct I/O	Enables or disables the Virtual Machine Monitor (VMM) from utilizing the additional hardware capabilities provided by Intel Virtualization technology for direct I/O. <ul style="list-style-type: none"> • Enable Intel Virtualization Technology for Direct I/O - This option is disabled by default.

Table 6. Security

Option	Description
Intel TXT (LT-SX) Configuration	This option is disabled by default.
Admin Password	Allows you to set, change, or delete the administrator (admin) password. <ul style="list-style-type: none">  NOTE: You must set the admin password before you set the system password.  NOTE: Successful password changes take effect immediately.  NOTE: Deleting the admin password automatically deletes the system password.  NOTE: Successful password changes take effect immediately. Default Setting: Not set
System Password	Allows you to set, change or delete the system password. <ul style="list-style-type: none">  NOTE: Successful password changes take effect immediately. Default Setting: Not set
Strong Password	Allows you to enforce the option to always set strong passwords. Default Setting: Enable Strong Password is not selected.
Password Configuration	You can define the length of your password. Min = 4 , Max = 32
Password Bypass	Allows you to enable or disable the permission to bypass the System password, when it is set. The options are: <ul style="list-style-type: none"> • Disabled (Default Setting) • Reboot bypass

Option	Description
Password Change	Allows you to enable the disable permission to the System passwords when the administrator password is set. Default Setting: Allow Non-Admin Password Changes is not selected
TPM Security	Allows you to enable the Trusted Platform Module (TPM) during POST. Default Setting: The option is disabled.
CPU XD Support	Allows you to enable the Execute Disable mode of the processor. Default Setting: Enable CPU XD Support
Computrace	Allows you to activate or disable the optional Computrace software. The options are: <ul style="list-style-type: none"> • Deactivate (Default Setting) • Disable • Activate  NOTE: The Activate and Disable options will permanently activate or disable the feature and no further changes will be allowed.
Chassis Intrusion	This option is disabled by default.
Admin Setup Lockout	Allows you to prevent users from entering Setup when an administrator password is set. Default Setting: Disabled

Table 7. Power Management

Option	Description
AC Recovery	Specifies how the computer will respond when AC power is applied after a AC power loss. You can set the AC Recovery to: <ul style="list-style-type: none"> • Power Off (Default Setting) • Power On • Last Power State
Auto On Time	Allows you to set the time at which the computer must turn on automatically. The options are: <ul style="list-style-type: none"> • Disabled (Default Setting) • Every Day • Weekdays
Deep Sleep Control	Allows you to define the controls when Deep Sleep is enabled. <ul style="list-style-type: none"> • Disabled (Default Setting) • Enabled in S5 only • Enabled in S4 and S5
Fan Control Override	Controls the speed of the system fan. The default setting is set to Auto.
Wake on LAN	This option allows the computer to power up from the off state when triggered by a special LAN signal. Wake-up from the Standby state is unaffected by this setting and must be enabled in the operating system. This feature only works when the computer is connected to AC power supply.

Option	Description
	<ul style="list-style-type: none"> • Disabled - Does not allow the system to power on by special LAN signals when it receives a wake-up signal from the LAN or wireless LAN. • LAN Only - Allows the system to be powered on by special LAN signals. <p>This option is Disabled by default.</p>

Table 8. Maintenance

Option	Description
Service Tag	Displays the service tag of your computer.
Asset Tag	Allows you to create a system asset tag if an asset tag is not already set. This option is not set by default.
SERR Messages	Controls the SERR message mechanism. This option is not set by default. Some graphics cards require that the SERR message mechanism be disabled.

Table 9. POST Behavior



Option	Description
Numlock LED	Specifies if the NumLock function can be enabled when the system boots. This option is enabled by default.
Keyboard Errors	Specifies whether keyboard related errors are reported when it boots. This option is enabled by default.
POST Hotkeys	Specifies whether the sign-on screen displays a message, that displays the keystroke sequence required to enter the BIOS Boot Option Menu. <ul style="list-style-type: none"> • Enable F12 Boot Option menu - This option is enabled by default.

Table 10. System Logs

Option	Description
BIOS events	Displays the system event log and allows you to clear the log. <ul style="list-style-type: none"> • Clear Log

Updating the BIOS

It is recommended to update your BIOS (system setup), on replacing the system board or if an update is available. For notebooks, ensure that your computer battery is fully charged and connected to a power outlet

1. Restart the computer.
2. Go to support.dell.com/support/downloads.
3. If you have your computer's Service Tag or Express Service Code:
 -  **NOTE:** For desktops, the service tag label is available on the front of your computer.
 -  **NOTE:** For notebooks, the service tag label is available on the bottom of your computer.
 - a. Enter the **Service Tag** or **Express Service Code** and click **Submit**.

- b. Click **Submit** and proceed to step 5.
4. If you do not have your computer's service tag or express service code, select one of the following:
 - a. **Automatically detect my Service Tag for me**
 - b. **Choose from My Products and Services List**
 - c. **Choose from a list of all Dell products**
5. On the application and drivers screen, under the **Operating System** drop-down list, select **BIOS**.
6. Identify the latest BIOS file and click **Download File**.
7. Select your preferred download method in the **Please select your download method below window**; click **Download Now**.
The **File Download** window appears.
8. Click **Save** to save the file on your computer.
9. Click **Run** to install the updated BIOS settings on your computer.
Follow the instructions on the screen.

System and Setup Password

You can create a system password and a setup password to secure your computer.

Password Type	Description
System password	Password that you must enter to log on to your system.
Setup password	Password that you must enter to access and make changes to the BIOS settings of your computer.

 **CAUTION:** The password features provide a basic level of security for the data on your computer.

 **CAUTION:** Anyone can access the data stored on your computer if it is not locked and left unattended.

 **NOTE:** Your computer is shipped with the system and setup password feature disabled.

Assigning a System Password and Setup Password

You can assign a new **System Password** and/or **Setup Password** or change an existing **System Password** and/or **Setup Password** only when **Password Status** is **Unlocked**. If the Password Status is **Locked**, you cannot change the System Password.

 **NOTE:** If the password jumper is disabled, the existing System Password and Setup Password is deleted and you need not provide the system password to log on to the computer.

To enter a system setup, press <F2> immediately after a power-on or reboot.

1. In the **System BIOS** or **System Setup** screen, select **System Security** and press <Enter>.
The **System Security** screen appears.
2. In the **System Security** screen, verify that **Password Status** is **Unlocked**.
3. Select **System Password**, enter your system password, and press <Enter> or <Tab>.
Use the following guidelines to assign the system password:
 - A password can have up to 32 characters.
 - The password can contain the numbers 0 through 9.

- Only lower case letters are valid, upper case letters are not allowed.
- Only the following special characters are allowed: space, ("), (+), (.), (-), (.), (/), (;), (I), (\), (]), (^).

Re-enter the system password when prompted.

4. Type the system password that you entered earlier and click **OK**.
5. Select **Setup Password**, type your system password and press <Enter> or <Tab>. A message prompts you to re-type the setup password.
6. Type the setup password that you entered earlier and click **OK**.
7. Press <Esc> and a message prompts you to save the changes.
8. Press <Y> to save the changes. The computer reboots.

Deleting or Changing an Existing System and/or Setup Password

Ensure that the **Password Status** is Unlocked (in the System Setup) before attempting to delete or change the existing System and/or Setup password. You cannot delete or change an existing System or Setup password, if the **Password Status** is Locked.



To enter the System Setup, press <F2> immediately after a power-on or reboot.

1. In the **System BIOS** or **System Setup** screen, select **System Security** and press <Enter>. The **System Security** screen is displayed.
2. In the **System Security** screen, verify that **Password Status** is **Unlocked**.
3. Select **System Password**, alter or delete the existing system password and press <Enter> or <Tab>.
4. Select **Setup Password**, alter or delete the existing setup password and press <Enter> or <Tab>.
 -  **NOTE:** If you change the System and/or Setup password, re-enter the new password when prompted. If you delete the System and/or Setup password, confirm the deletion when prompted.
5. Press <Esc> and a message prompts you to save the changes.
6. Press <Y> to save the changes and exit from the System Setup. The computer reboots.

Disabling a System Password

The system's software security features include a system password and a setup password. The password jumper disables any password(s) currently in use. There are 2-pins for the PSWD jumper.

 **NOTE:** The password jumper is disabled by default.

1. Follow the procedures in *Before Working Inside Your Computer*.
2. Remove the cover.
3. Identify the PSWD jumper on the system board. For identifying the PSWD jumper on the system board, see the System Board Components.
4. Remove the PSWD jumper from the system board.
 -  **NOTE:** The existing passwords are not disabled (erased) until the computer boots without the jumper.
5. Install the cover.
 -  **NOTE:** If you assign a new system and/or setup password with the PSWD jumper installed, the system disables the new password(s) the next time it boots.

6. Connect the computer to the electrical outlet and power-on the computer.
7. Power-off the computer and disconnect the power cable from the electrical outlet.
8. Remove the cover.
9. Replace the jumper on the pins.
10. Install the cover.
11. Follow the procedures in *After Working Inside Your Computer*.
12. Power-on the computer.
13. Go to the system setup, and assign a new system or setup password.

Diagnostics

If you experience a problem with your computer, run the ePSA diagnostics before contacting Dell for technical assistance. The purpose of running diagnostics is to test your computer's hardware without requiring additional equipment or risking data loss. If you are unable to fix the problem yourself, service and support personnel can use the diagnostics results to help you solve the problem.

Enhanced Pre-Boot System Assessment (ePSA) Diagnostics

The ePSA diagnostics (also known as system diagnostics) performs a complete check of your hardware. The ePSA is embedded with the BIOS and is launched by the BIOS internally. The embedded system diagnostics provides a set of options for particular devices or device groups allowing you to:

- Run tests automatically or in an interactive mode
- Repeat tests
- Display or save test results
- Run thorough tests to introduce additional test options to provide extra information about the failed device(s)
- View status messages that inform you if tests are completed successfully
- View error messages that inform you of problems encountered during testing



CAUTION: Use the system diagnostics to test only your computer. Using this program with other computers may cause invalid results or error messages.



NOTE: Some tests for specific devices require user interaction. Always ensure that you are present at the computer terminal when the diagnostic tests are performed.

1. Power-on the computer.
2. As the computer boots, press the <F12> key as the Dell logo appears.
3. On the boot menu screen, select the **Diagnostics** option.
The **Enhanced Pre-boot System Assessment** window is displayed, listing all devices detected in the computer. The diagnostics starts running the tests on all the detected devices.
4. If you wish to run a diagnostic test on a specific device, press <Esc> and click **Yes** to stop the diagnostic test.
5. Select the device from the left pane and click **Run Tests**.
6. If there are any issues, error codes are displayed.
Note the error code and contact Dell.

Troubleshooting Your Computer

You can troubleshoot your computer using indicators like Diagnostic Lights, Beep Codes, and Error Messages during the operation of the computer.

Diagnostic LEDs

 **NOTE:** The diagnostic LEDs only serve as an indicator of the progress through the Power-On Self Test (POST) process. These LEDs do not indicate the problem that caused the POST routine to stop.

The diagnostic LEDs are located on the front of the chassis next to the power button. These diagnostic LEDs are only active and visible during the POST process. Once the operating system starts to load, they turn off and are no longer visible.

Each LED has two possible states of OFF or ON. The most significant bit is labeled with the number 1, and the other three are labeled 2, 3, and 4, as you go down or across the LED stack. The normal operating condition after POST is for all four LEDs to be ON and then turn off as the BIOS hands control over to the operating system.





 **NOTE:** The diagnostic lights will blink when the power button is amber or off, and will not blink when it is white.

Table 11. POST Diagnostic LED Patterns

Diagnostic LEDs		
	<ul style="list-style-type: none"> The computer is either turned off or is not receiving power The computer is booted and operating normally. 	<ul style="list-style-type: none"> If the computer is turned off, connect the AC power-supply and power-on the computer.
	PCI device configuration activity is in progress or PCI device failure was detected.	<ul style="list-style-type: none"> Remove all peripheral cards from the PCI and PCI-E slots and reboot the computer. If the computer boots, add the peripheral cards back one by one until you find the bad one.
	A possible processor failure has occurred.	<ul style="list-style-type: none"> Re-seat the processor.
	Memory modules are detected, but a memory power failure has occurred.	<ul style="list-style-type: none"> If two or more memory modules are installed, remove the modules, then reinstall one module and restart the computer. If the computer starts normally, continue to install additional memory modules (one at a time) until you have identified a faulty module or reinstalled all modules without error. If only one memory



A possible graphics card failure has occurred.

- module is installed, try moving it to a different DIMM connector and re-start the computer.
- If available, install verified working memory of the same type into your computer.
- Ensure that the display/monitor is plugged into a discrete graphic card.
- Re-seat any installed graphics cards.
- If available, install a working graphics card into your computer.

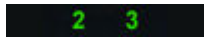

A possible hard drive failure has occurred.

- Re-seat all power and data cables.



A possible USB failure has occurred

- Reinstall all USB devices and check all cable connections.



No memory modules are detected.

- If two or more memory modules are installed, remove the modules, then reinstall one module and restart the computer. If the computer starts normally, continue to install additional memory modules (one at a time) until you have identified a faulty module or reinstalled all modules without error.
- If available, install working memory of the same type into your computer.



Power connector not installed properly.

- Re-seat the 2x2 power connector from the power supply unit.

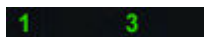

Memory modules are detected, but a memory configuration or compatibility error has occurred.

- Ensure that no special requirements for memory module/connector placement exist.
- Ensure that the memory you are using is supported by your computer.



A possible system board resource and/or hardware failure has occurred.

- Clear CMOS (Re-seat the coin-cell battery. See Removing and Installing Coin-cell Battery).
- Disconnect all internal and external peripherals, and restart the computer. If the computer boots, add the peripheral cards back one by one until you find the bad one.

1 2

A possible system board failure has occurred.

- If the problem persists, the system board / system board component is faulty.
- Disconnect all internal and external peripherals, and re-start the computer. If the computer boots, add the peripheral cards back one by one until you find the bad one.
- If the problem persists, the system board is faulty.

1 2 3

Some other failure has occurred.

- Ensure that the display/monitor is plugged into a discrete graphic card.
- Ensure that all hard drives and optical-drive cables are properly connected to the system board.
- If there is an error message on the screen identifying a problem with a device (such as the floppy drive or hard drive), check the device to make sure it is functioning properly.
- If the operating system is attempting to boot from a device (such as the floppy drive or optical drive), check system setup to ensure the boot sequence is correct for the devices installed on your computer.

4

System is in Recovery Mode

- BIOS checksum failure was detected and the system is now in recovery mode.

1 2 3 4

Boot hand off

- Indicates end of POST process. LEDs are normally in this state briefly as POST completes. Once the hand-off to the operating system is done, the LEDs turn off .

Error Messages

There are two types of BIOS error messages that are displayed depending on the severity of the issue. They are:

Errors That Do Not Halt Your Computer

These error messages will not halt your computer, but will display a warning message, pause for a few seconds, and then continue to boot. The following table lists the error messages.

Table 12. Errors that do not halt your computer

Error Message
Alert! Cover was previously removed.

Errors That Soft Halt Your Computer

These error messages will cause a soft halt of your computer and you will be prompted to press <F1> to continue or <F2> to enter the system setup. The following table lists the error messages.

Table 13. — Errors that soft halt your computer

Error Message
Alert! Front I/O Cable failure.
Alert! Left Memory fan failure.
Alert! Right Memory fan failure.
Alert! PCI fan failure.
Alert! Chipset heat sink not detected.
Alert! Hard Drive fan1 failure.
Alert! Hard Drive fan2 failure.
Alert! Hard Drive fan3 failure.
Alert! CPU 0 fan failure.
Alert! CPU 1 fan failure.
Alert! Memory related failure detected.
Alert! Correctable memory error has been detected in memory slot DIMMx.
Warning: Non-optimal memory population detected. For increased memory bandwidth populate DIMM connectors with white latches before those with black latches.
Your current power supply does not support the recent configuration changes made to your system. Please contact Dell Technical support team to learn about upgrading to a higher wattage power supply.
Dell Reliable Memory Technology (RMT) has discovered and isolated errors in system memory. You may continue to work. Memory module replacement is recommended. Please refer to the RMT Event log screen in BIOS setup for specific DIMM information.
Dell Reliable Memory Technology (RMT) has discovered and isolated errors in system memory. You may continue to work. Additional errors will not be isolated. Memory module replacement is recommended. Please refer to the RMT Event log screen in BIOS setup for specific DIMM information.

Technical Specifications

 **NOTE:** Offerings may vary by region. The following specifications are only those required by law to ship with your computer. For more information regarding the configuration of your computer, click **Start** → **Help and Support** and select the option to view information about your computer.

Table 14. Processor

Feature	Specification
Type	4, 6, and 8 core Intel Xeon Processor
Cache	
Instruction Cache	32 KB
Data Cache	32 KB
	256 KB Mid-Level Cache per core
	up to 20 MB (4C: 10 MB, 6C: 15 MB/12 MB, 8C: 20 MB) Last-Level Cache shared among all cores

Table 15. System Information

Feature	Specification
Chipset	Intel C600 chipset
BIOS chip (NVRAM)	8 MB + 4 MB serial flash EEPROM

Table 16. Memory

Feature	Specification
Memory module connector	
T3600	4 DIMM slots
T5600	8 DIMM slots
T7600	16 DIMM slots
Memory module capacity	
T3600 / T5600	1 GB, 2 GB, 4 GB, 8 GB, and 16 GB
T7600	1 GB, 2 GB, 4 GB, 8 GB, 16 GB, and 32 GB
Type	
T3600	1333 and 1600 DDR3 RDIMM ECC/Non-ECC
T5600	1333 and 1600 DDR3 RDIMM ECC
T7600	1333 and 1600 DDR3 RDIMM and 32 GB LRDIMM ECC
Minimum memory	

Feature	Specification
T3600	2 GB
T5600 / T7600	4 GB
Maximum memory	
T3600	64 GB
T5600	128 GB
T7600	512 GB

Table 17. Video

Feature	Specification
Discrete (PCIe 3.0/2.0 x16)	
T3600	up to 2 full-height, full-length (maximum of 300 W)
T5600	up to 2 full-height, full-length (maximum of 300 W)
T7600	up to 4 full-height, full length (maximum of 600 W)

Table 18. Audio

Feature	Specification
Integrated	Realtek ALC269 audio codec

Table 19. Network

Feature	Specification
T3600 / T5600	Intel 82759
T7600	Intel 82759 and Intel 82754

Table 20. Expansion Bus

Feature	Specification
Bus Type:	PCI Express 3.0 PCI Express 2.0 PCI 2.3 SAS SATA , SATA 2.0 USB 2.0, USB 3.0
Bus Speed:	PCI Express: <ul style="list-style-type: none"> • 3.0 x4 slot: 4 GB/s • 3.0 x16 slots: 16 GB/s • 2.0 x4 slot: 2 GB/s

Feature	Specification
	PCI 2.3 (32-bit, 33 MHz): 133 MB/s
	SAS – 3 Gbps
	SATA – 1.5 Gbps and 3.0 Gbps
	USB – 1.2 Mbps Low Speed, 12 Mbps Full Speed, 480 Mbps High Speed, 5 Gbps Super Speed

Table 21. Drives

Feature	Specification
T3600 /T5600	
Externally accessible:	
Slimline SATA optical bays	one
5.25-inch drive bays	one; supports one 5.25-inches SATA device, one media card reader, or up to two 2.5-inches SAS/SATA/HDDs/SSDs (with optional adapters)
Internally accessible	
3.5-inch hard drive bays	two; supporting two 3.5-inches SATA or 2.5-inches SAS/SATA/HDD/SSDs.
T7600	
Externally accessible:	
Slimline SATA optical bays:	one
5.25-inch drive bays	one; supports one 5.25-inches device, one media card reader, or up to four 2.5-inches hard drives (with optional adapters)
3.5-inch hard drive bays	four
Internally accessible	none

Table 22. External Connectors

Feature	Specification
Audio	<ul style="list-style-type: none"> • front panel — Mic-in, headphone-out • back panel — Line-out, Mic In/Line In
Network	
T3600/T5600	one RJ-45
T7600	two RJ-45
Serial	one 9-pin connector
USB	
T3600 / T5600 / T7600	<ul style="list-style-type: none"> • front panel — three USB 2.0, and one USB 3.0 • back panel — five USB 2.0, and one USB 3.0 • internal — three USB 2.0

Feature	Specification
Video	Video card dependent <ul style="list-style-type: none"> • DVI connector • DisplayPort • DMS-59

Table 23. Internal Connectors

Feature	Specification
System power	one 28-pin connector
System fans	three four-pin connectors
Processor fans	
T3600	one 5-pin connector
T5600/T7600	two 5-pin connectors
HDD fans	
T3600 / T5600	one 5-pin connector
T7600	three 5-pin connectors
Memory	
T3600	four 240-pin connectors
T5600	eight 240-pin connectors
T7600	sixteen 240-pin connectors
Processor	
T3600	one LGA-2011 socket
T5600/T7600	two LGA-2011 sockets
Back I/O:	
PCI Express	
PCI Express x4	
T3600 / T5600	two 164-pin connectors
T7600	one 98-pin connector, one 164-pin connector
PCI Express x16	
T3600 / T5600	two 164-pin connectors
T7600	two 164-pin connectors (four when optional second processor is installed)
PCI 2.3	one 124-pin connector
Front I/O:	
Front USB	one 14-pin connector
Internal USB	one type A female, one dual-port 2x5 header
Front panel control	one 2x14 pin connector

Feature	Specification
Front panel audio HDA header	one 2x5 pin connector
HDD Back Panel :	
SATA	
T3600	four 7-pin SAS/SATA connectors
T5600	one 36-pin mini-SAS connector, four 7-pin SAS/SATA connectors
T7600	two 36-pin mini-SAS connectors
Power	
T3600	one 24-pin and one 8-pin connector
T5600	one 24-pin and two 8-pin connectors
T7600	one 24-pin and one 20-pin connector

Table 24. Controls and Lights

Feature	Specification
Power button light:	off — system is off or unplugged. solid white light — computer is operating normally. blinking white light — computer is in stand by. solid amber light — the computer does not start, indicating a problem with the system board or power supply. blinking amber light — indicates a problem has occurred with the system board.
Drive activity light	white light — blinking white light indicates that the computer is reading data from, or writing data to the hard drive.
Network link integrity lights (back panel)	green light — A good connection at 10 Mbs exists between the network and the computer. orange light — A good connection at 100 Mbs exists between the network and the computer. yellow light — A good connection at 1000 Mbs exists between the network and the computer.
Network activity lights (back panel)	yellow light — flashes when there is network activity on the connection.
Diagnostic lights:	off — computer is off or has completed POST. amber/blinking light — see the service manual for specific diagnostic codes.

Table 25. Power

Feature	Specification
Coin-cell battery	3 V CR2032 lithium coin cell
Voltage	100 VAC to 240 VAC
Wattage	

Feature	Specification
T3600	635 / 425 W (input voltage of 100 VAC – 240 VAC)
T5600	825 / 635 W (input voltage of 100 VAC – 240 VAC)
T7600	1000 W (input voltage 100 VAC – 107 VAC) 1300 W (input voltage 181 VAC – 240 VAC) 1100 W (input voltage 108 VAC – 180 VAC)
Maximum heat dissipation	
1300 W	4113.00 BTU/hr
825 W	3086.60 BTU/hr
635 W	2484.00 BTU/hr
425 W	1450.10 BTU/hr



NOTE: Heat dissipation is calculated by using the power supply wattage rating.

Table 26. Physical

Feature	Specification
T5600	
Height (with feet)	416.90 mm (16.41 inches)
Height (without feet)	414.00 mm (16.30 inches)
T3600	
Height (with feet)	175.50 mm (6.91 inches)
Height (without feet)	414.00 mm (16.30 inches)
T5600/T3600	
Width	172.60 mm (6.79 inches)
Depth	471.00 mm (18.54 inches)
Weight (minimum):	14.00 kg (30.86 lb) / 13.2 kg (29.10 lb)
T7600	
Height (with feet)	433.40 mm (17.06 inches)
Height (without feet)	430.50 mm (16.95 inches)
Width	216.00 mm (8.51 inches)
Depth	525.00 mm (20.67 inches)
Weight (minimum):	16.90 kg (37.26 lb)

Table 27. Environmental

Feature	Specification
Temperature:	
Operating	10 °C to 35 °C (50 °F to 95 °F)

Feature	Specification
Storage	-40 °C to 65 °C (-40° F to 149 °F)
Relative humidity (maximum)	20% to 80% (noncondensing)
Maximum vibration:	
Operating	5 Hz to 350 Hz at 0.0002 G ² /Hz
Storage	5 Hz to 500 Hz at 0.001 to 0.01 G ² /Hz
Maximum shock:	
Operating	40 G +/- 5% with pulse duration of 2 msec +/- 10% (equivalent to 51 cm/sec [20 in/sec])
Storage	105 G +/- 5% with pulse duration of 2 msec +/- 10% (equivalent to 127 cm/sec [50 in/sec])
Altitude:	
Operating	-15.2 m to 3048 m (-50 ft to 10,000 ft)
Storage	-15.2 m to 10,668 m (-50 ft to 35,000 ft)
Airborne contaminant level	G1 as defined by ISA-S71.04-1985

Contacting Dell

 **NOTE:** If you do not have an active Internet connection, you can find contact information on your purchase invoice, packing slip, bill, or Dell product catalog.

Dell provides several online and telephone-based support and service options. Availability varies by country and product, and some services may not be available in your area. To contact Dell for sales, technical support, or customer service issues:

1. Go to **support.dell.com**.
2. Select your support category.
3. Verify your country or region in the **Choose a Country/Region** drop-down list at the bottom of the page.
4. Select the appropriate service or support link based on your need.